

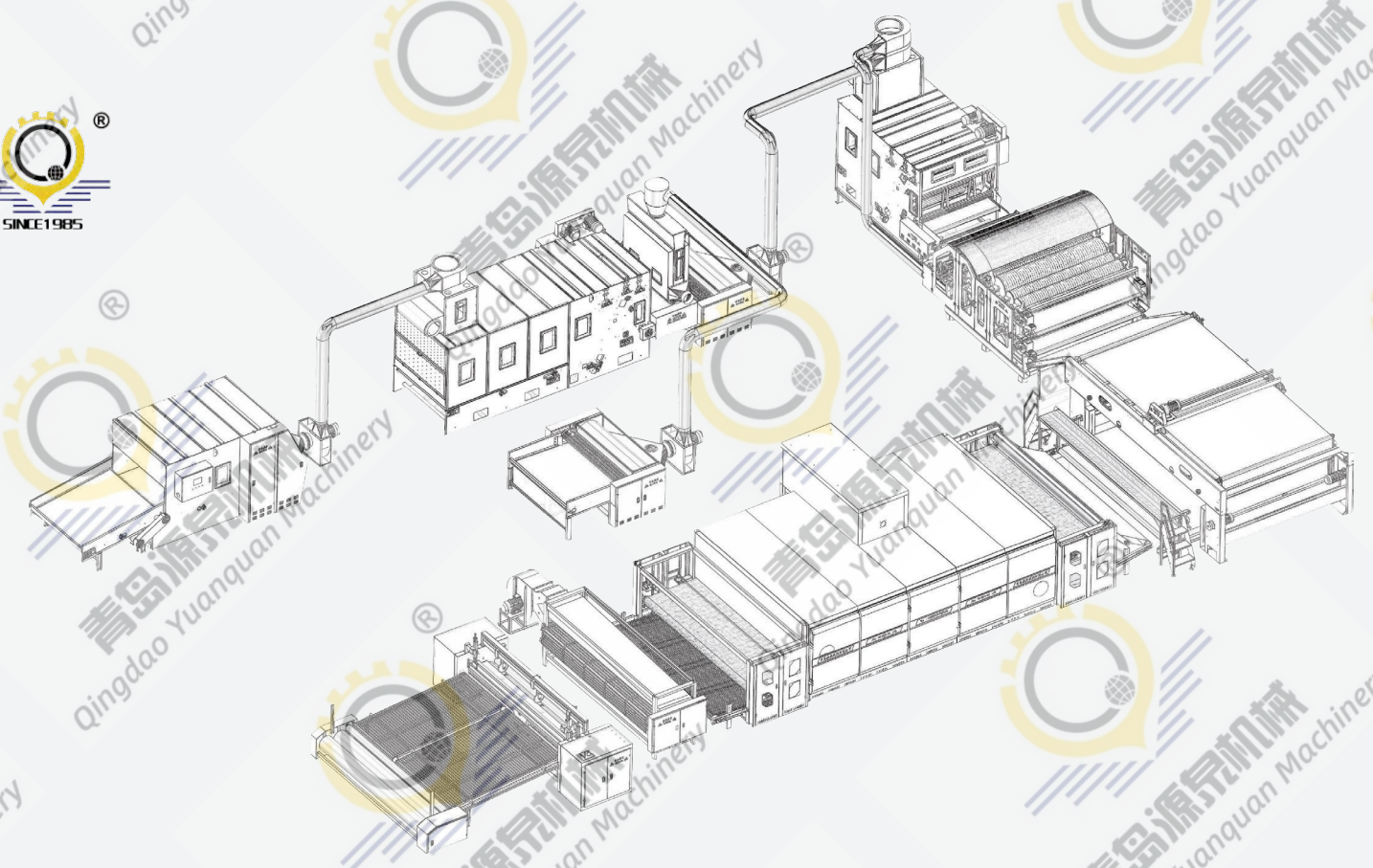

青岛源泉机械有限公司  
Qingdao Yuanquan Machinery Co., Ltd.



SINCE 1985



# PRODUCT CATALOG

## 产品册

Non-Woven Machinery  
无纺机械

**青岛源泉机械有限公司**  
Qingdao Yuanquan Machinery Co., Ltd.

青岛总公司: 13505325035 (张)  
南通办事处: 13831973546 (王)  
国际业务部: 13256827480 (王)  
地址: 山东省青岛市胶州市洋河镇艾山工业聚集区  
邮箱: yq01@yuanquanmachinery.com  
中文官网: www.qdyuanquan.com (Chinese)  
英文官网: www.yuanquanmh.com (English)  
阿里巴巴国内: https://yuanquan.1688.com  
阿里巴巴国际: http://qdyuanquanmachine.en.alibaba.com



English



中文

追求卓越品质 - 缔造世界品牌  
BEST QUALITY TO CREATE A WORLD BRAND



# 企业介绍

## COMPANY INTRODUCTION

青岛源泉机械有限公司始建于1985年，是一家专业从事动物纤维分梳设备，无纺设备，研发制造的生产型企业，集研发、生产、销售于一体。目前公司已经形成了“一基两翼”的产品线格局，即以动物纤维分梳设备的生产、销售为基础，以小型纺纱打样设备和非织造布全套设备的制造为两翼，为源泉机械的发展、壮大提供源源不断的动力。

公司注重科技创新与发展，拥有专业的非织造布设备研发团队。其中主要产品有：纤维混开料设备，梳理成网设备，各种形式的烘箱、针刺机等单机和无纺生产线。源泉机械凭借丰富的实践经验和完善的团队服务，为全球客户提供专业的非织造布产品解决方案。

Founded in 1985, Qingdao Yuanquan Machinery Co.,Ltd is a production-oriented enterprise specializing in the R&D and manufacturing of animal fiber carding equipment and non-woven equipment, integrating R&D, production and sales. At present, the company has formed a "one base and two wings" product line structure, that is, based on the production and sales of animal fiber carding equipment, with the manufacturing of small spinning sampling equipment and a complete set of non-woven equipment as two wings, and as the source of Yuanquan Machinery. Development and growth provide a steady stream of power.

Yuanquan Machinery always focuses on technological innovation and development and has a professional non-woven equipment R&D team. The main products include: fiber mixing and opening equipment, carding & fiber layer/web forming equipment, different types of oven, needle loom, other unit machines and all ranges of non woven production lines. With rich practical experience and comprehensive team service, Yuanquan Machinery provides professional solutions for non-woven design to global customers.



# 企业荣誉

## CORPORATE HONOR

Authorized Patent



Certificate



Software copyright



Utility patent





# YQ-1600-3HL 称重式三辊混料机

YUAN QUAN MACHINERY Three Roller Fiber Mixing Machine With Weighing System

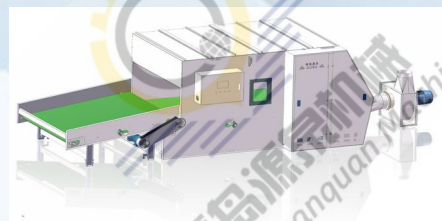
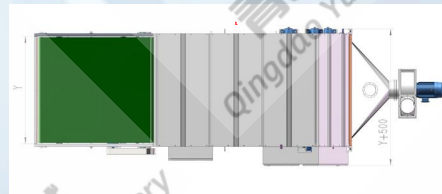
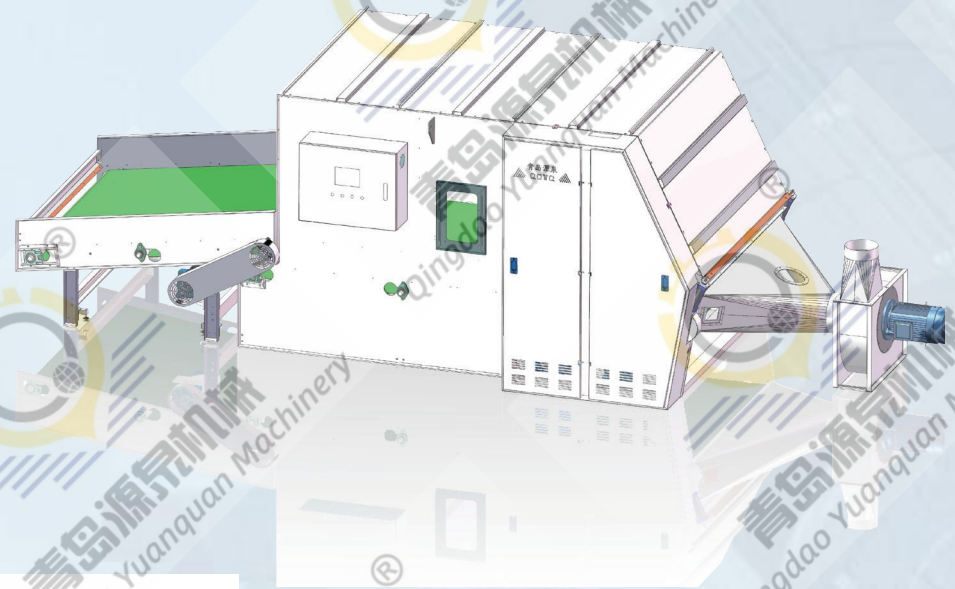

## 产品介绍

### PRODUCT INTRODUCTION

After electronically weighing various fibers, they are fed into the flat curtain and conveyed to the main mixing bin. After being opened and mixed by three opening rollers at high speed, the fibers are transported by the conveying fan with an appropriate amount of air volume for later work. The fibers after being opened and mixed by this machine have good effect and are mixed evenly for carding.

把各种捆包纤维、原料经电子称重后，喂入平帘输送至主体混仓内，再由三道开松辊高速开松混合后，经输棉风机以适量的风量输送纤维原料供后道工作使用。经本机开松混合后的纤维，原料效果好，混合均匀，以备梳理使用。

## 产品细节

### PRODUCT DETAILS



## 主要规格及参数

### MAIN SPECIFICATIONS AND PARAMETERS

型号 Model	工作幅宽 Working Width mm	外形尺寸 Dimension L×W×H (mm)			重量 Wt kg	产量 Output kg/h	功率 Power			
							平帘电机 Flat Curtain Motor	主电机 Main Motor	风机 Fan	称重电机 Weighing Motor
YQ-1600-3HL	1600	6500	2100	2000	About 1600	250-400	1.5	7.5	5.5	0.75
YQ-1800-3HL	1800	6500	2300	2000	About 1800	300-450	1.5	7.5	5.5	0.75
YQ-2000-3HL	2000	6500	2500	2000	About 2000	350-500	1.5	7.5	5.5	0.75
YQ-2200-3HL	2200	6500	2700	2000	About 2200	400-550	1.5	7.5	5.5	0.75

# YQ-1600-5HL 称重式五辊混料机

YUAN QUAN MACHINERY Five Roller Fiber Mixing Machine With Weighing System

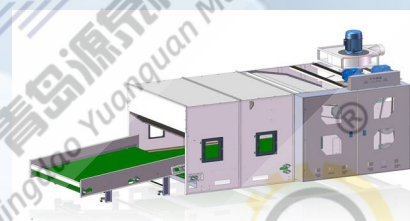
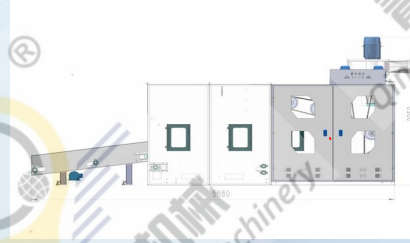
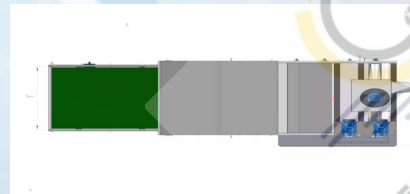
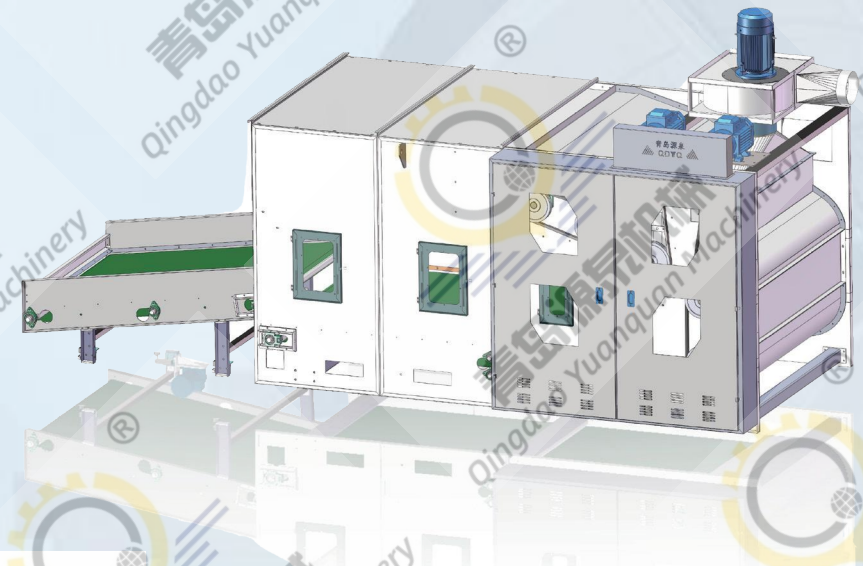

## 产品介绍

### PRODUCT INTRODUCTION

The fibers after opening are fed into the flat curtain and transported to the main mixing bin. After being opened and mixed at high speed by five opening rollers, the fibers are transported by the conveying fan with an appropriate amount of air volume for subsequent work. This machine uses two motors to control five opening rollers, so that the working speed and operation is more stable.

将开包后称量分配好的纤维，喂入平帘输送至主体混仓内，再由5道开松辊高速开松混合后，经输棉风机以适量的风量输送纤维原料供后道工作使用。本机由双电机控制五道开松辊，转速、运行更加稳定。

## 产品细节

### PRODUCT DETAILS



## 主要规格及参数

### MAIN SPECIFICATIONS AND PARAMETERS

型号 Model	工作幅宽 Working Width mm	外形尺寸 Dimension L×W×H (mm)			重量 Wt kg	产量 Output kg/h	功率 Power			
							主电机 Main Motor	平帘电机 Flat Curtain Motor	风机 Fan	称重电机 Weighing Motor
YQ-1600-5HL	1600	5880	2200	2950	About 3200	250-400	5.5kw×2=11kw	1.5	5.5	0.75
YQ-1800-5HL	1800	5880	2400	2950	About 3500	200-350	5.5kw×2=11kw	1.5	5.5	0.75
YQ-2000-5HL	2000	5880	2600	2950	About 4000	260-460	5.5kw×2=11kw	1.5	5.5	0.75



# YQ-1200-KB 称重式开包机

YUAN QUAN MACHINERY Bale Opener With Weighing System

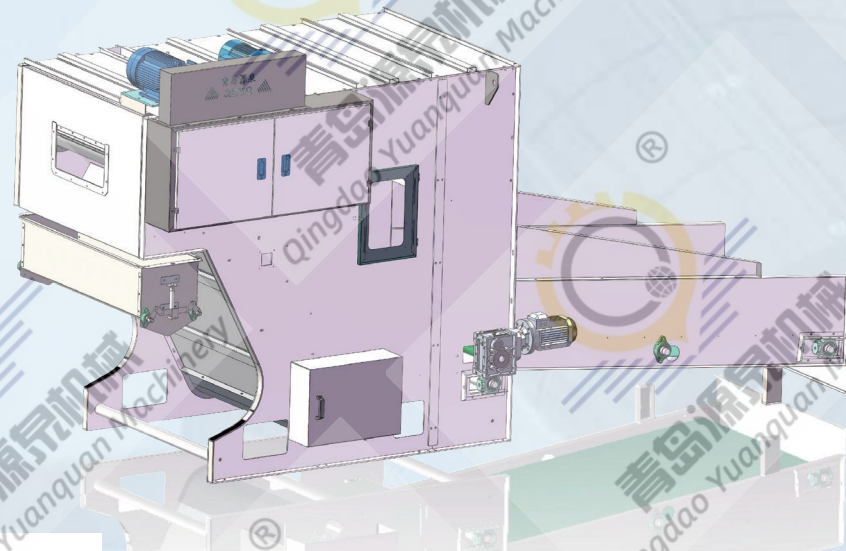

## 产品介绍

This machine is mainly used to open various fibers and fibers can be fed quantitatively. Multiple machines can be used to mix different fibers in proportion. It adopts automatic control and wide adjustment range, so that the ratio of different fibers is accurate and evenly mixed. Another advantage is that it uses a new electronic weighing structure to save labor.

该机器主要用于开松各种等级捆包纤维，且能够定量喂入。多台复合使用可按比例混合不同纤维。采用自动控制，调节范围大，使不同纤维配比准确，混合均匀，使用新式电子称重结构，更加节省人工。

## 产品细节

### PRODUCT DETAILS

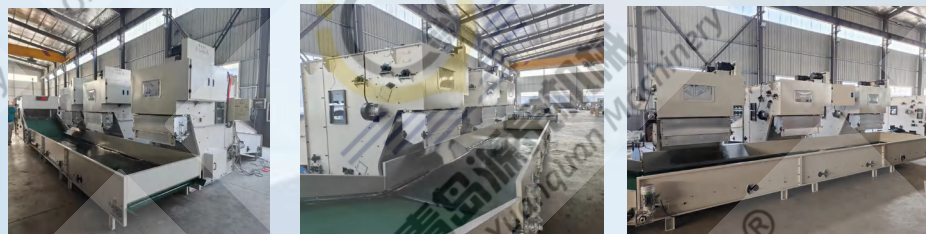

## 主要规格及参数

### MAIN SPECIFICATIONS AND PARAMETERS

型号 Model	工作幅宽 Working Width mm	外形尺寸 Dimension L×W×H (mm)			重量 Wt kg	产量 Output kg/h	功率 Power			
							斜帘电机 Inclined Motor	滚筒电机 Drum Motor	吹风电机 Blowing Motor	平帘电机 Flat Curtain Motor
YQ-1000-KB	1000	4750	1400	2500	About 1300	80-180	1.5	1.5	0.25	1.1
YQ-1200-KB	1200	4750	1600	2500	About 1400	150-250	1.5	1.5	0.25	1.1
YQ-1300-KB	1300	4750	1700	2500	About 1500	180-300	1.5	1.5	0.25	1.1

# YQ-1600-CM 大仓储棉机

YUAN QUAN MACHINERY Big Chamber Fiber Storage Machine

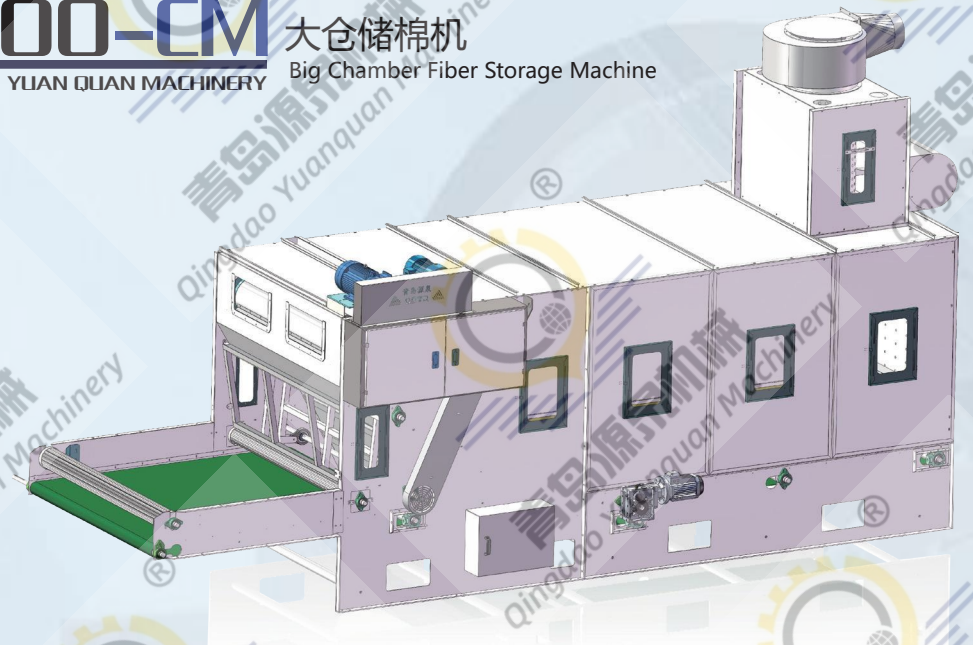

## 产品介绍

### PRODUCT INTRODUCTION

After preliminary mixing, the fibers are fed into the upper fiber collection box of the machine through the conveying fan, which is achieved through a feeding pipe. The fibers are sent to the opening roller through the upper feeding roller for further opening, and then fall into the lower fiber collection box, during which the fibers will be mixed again. After passing through the vibrating screen, the fiber layer enters the next process.

将经过粗开松混合后的纤维经输棉风机送入送料管道进入本机上棉箱，经上给棉罗拉送至开松辊进一步开松后落入下棉箱，这一过程再次混合原料，经由振动筛，振实后形成篷棉层进入下道工序。

## 产品细节

### PRODUCT DETAILS



## 主要规格及参数

### MAIN SPECIFICATIONS AND PARAMETERS

型号 Model	工作幅宽 Working Width mm	外形尺寸 Dimension L×W×H (mm)			重量 Wt kg	产量 Output kg/h	功率 Power			
							滚筒电机 Drum Motor	斜帘电机 Inclined Curtain Motor	平帘电机 Flat Curtain Motor	吹风电机 Blowing Motor
YQ-1600-CM	1600	6500	2250	3500	About 1600	180-600	2.2	1.5	1.1	0.25
YQ-1800-CM	1800	6500	2450	3500	About 1800	180-700	2.2	1.5	1.1	0.25
YQ-2000-CM	2000	6500	2650	3500	About 2000	180-800	2.2	1.5	1.1	0.25



# YQ-1600-KS 开松机

YUAN QUAN MACHINERY Fiber Opening Machine

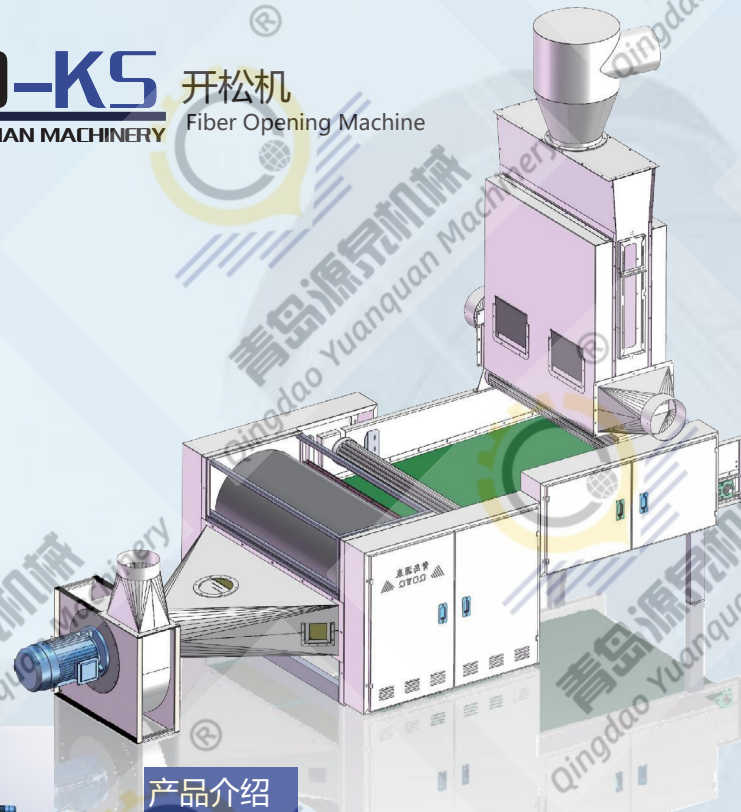

## 产品介绍

### PRODUCT INTRODUCTION

The fibers are transported to the feeding roller through the feeding flat curtain. After being opened by the opening roller at high speed, the fibers are transported by the fiber conveying fan with an appropriate amount of air volume for the later work. The fibers after being opened by this machine have good results, are more uniform and fine.

把纤维、原料经喂入平帘输送至喂入罗拉，再由开松辊高速开松后，经输棉风机以适量的风量输送纤维原料供后道工序使用。经本机开松后的纤维、原料效果好，均匀、细致。

## 产品细节

### PRODUCT DETAILS

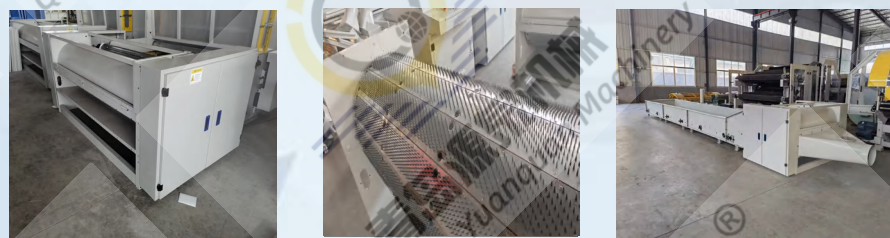

## 主要规格及参数

### MAIN SPECIFICATIONS AND PARAMETERS

型号 Model	工作幅宽 Working Width mm	外形尺寸 Dimension L×W×H (mm)		重量 Wt kg	产量 Output kg/h	功率 Power			
						主电机 Main Motor	喂入罗拉 Feeding Roller	风机 Fan	
									kw
YQ-1300-KS	1300	4100	1850	3450	About 1000	100-300	7.5	1.5	5.5
YQ-1600-KS	1600	4100	2150	3450	About 1000	100-350	7.5	1.5	5.5
YQ-1800-KS	1800	4100	2350	3450	About 1000	150-350	7.5	1.5	5.5
YQ-2000-KS	2000	4100	2550	3450	About 1100	200-400	7.5	1.5	5.5

# YQ-1000-BKS 边角料开松机

YUAN QUAN MACHINERY Waste Fabric Opening Machine

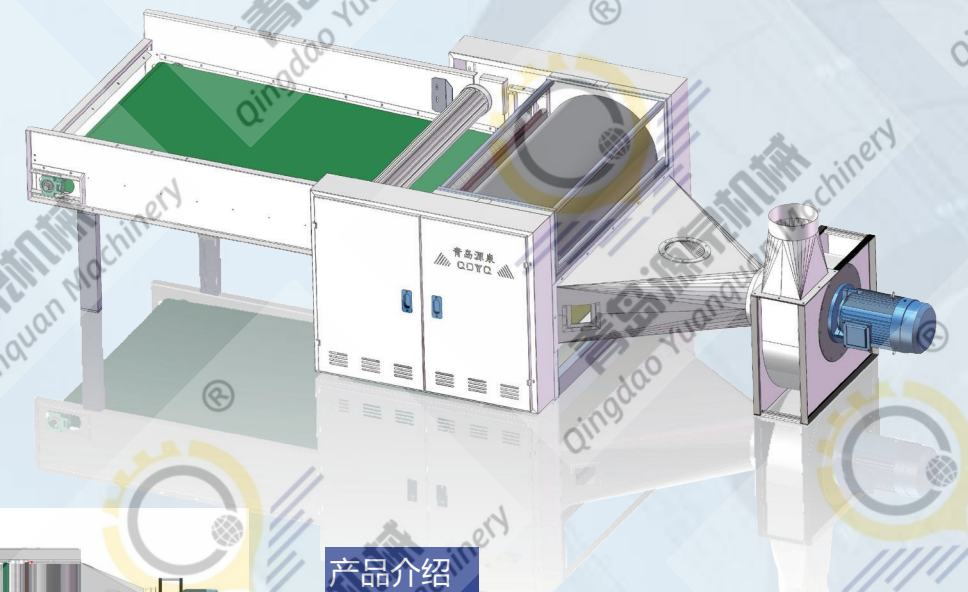

## 产品介绍

### PRODUCT INTRODUCTION

This machine is used to open and recycle the remaining leftover materials (waste fabric) after cutting, thereby maximizing the utilization of raw materials and reducing production costs for production enterprises. This machine can be divided into card clothing type and steel wire type, which can be selected according to different fibers.

本机用于将切片后剩余的边角料进行开松回收，从而使原料的利用率达到最大化，减少生产企业的生产成本。该机器又可分为针布式和尺条式，可根据不同原料进行选择。

## 产品细节

### PRODUCT DETAILS



## 主要规格及参数

### MAIN SPECIFICATIONS AND PARAMETERS

型号 Model	工作幅宽 Working Width mm	外形尺寸 Dimension L×W×H (mm)			重量 Wt kg	产量 Output kg/h	功率 Power		
							主电机 Main Motor	喂入罗拉 Feeding Roller	风机 Fan
YQ-500-BKS	500	4200	1050	1050	About 400	100-250	5.5	1.5	5.5
YQ-800-BKS	800	4200	1350	1050	About 600	150-350	5.5	1.5	5.5
YQ-1000-BKS	1000	4200	1550	1050	About 800	150-450	5.5	1.5	5.5
YQ-1300-BKS	1300	4200	1850	1050	About 1000	150-500	5.5	1.5	5.5



# YQ-2100-WL 喂料机

YUAN QUAN MACHINERY Feeding Machine

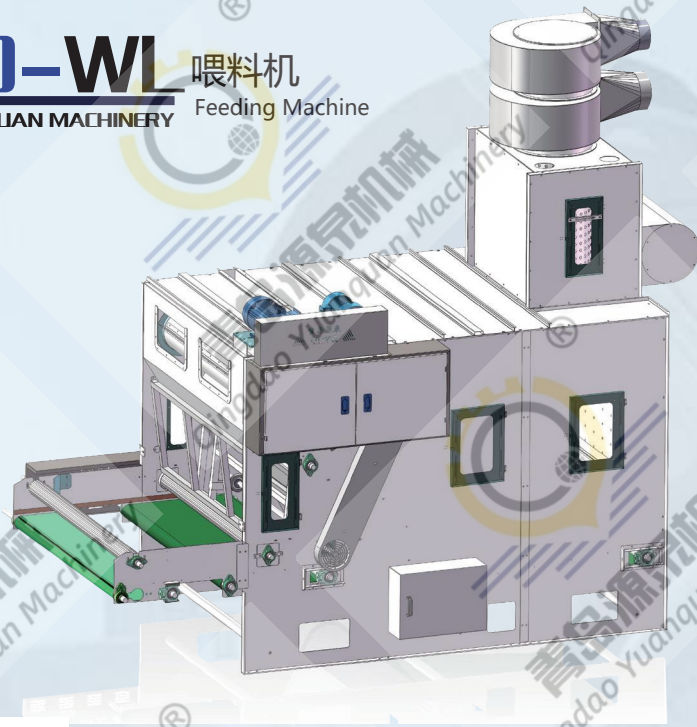

## 产品介绍

### PRODUCT INTRODUCTION

This machine is used to transport the fiber (after opening and mixing) to the carding machine for next process. It uses vibration assistance for volumetric quantitative feeding, with photoelectric control synchronized with the main opener, which ensures more accurate and uniform feeding.

这台机器用于将纤维（开松和混合后）输送到梳理机进行下一道工序。采用容积式定量振动喂入，光电控制，与主开松光电联动，给棉量更加均匀准确。

## 产品细节

### PRODUCT DETAILS



## 主要规格及参数

### MAIN SPECIFICATIONS AND PARAMETERS

型号 Model	工作幅宽 Working Width mm	外形尺寸 Dimension L×W×H (mm)		产量 Output kg/h	重量 Weight kg	功率 Power			
						滚筒电机 Drum Motor	斜帘电机 Inclined Motor	吹风电机 Blowing Motor	
YQ-1600-WL	1600	3950	2250	3950	100-300	About 1800	2.2	1.5	0.25
YQ-1800-WL	1850	3950	2450	3950	100-350	About 2000	2.2	1.5	0.25
YQ-2100-WL	2100	3950	2750	3950	100-400	About 2300	2.2	1.5	0.25
YQ-2300-WL	2300	3950	2950	3950	100-450	About 2500	2.2	1.5	0.25
YQ-2600-WL	2600	3950	3250	3950	100-500	About 2800	2.2	1.5	0.25

# YQ-2300-DSL 单锡林双道夫梳理机

YUAN QUAN MACHINERY Single Cylinder Double Doffer Carding Machine

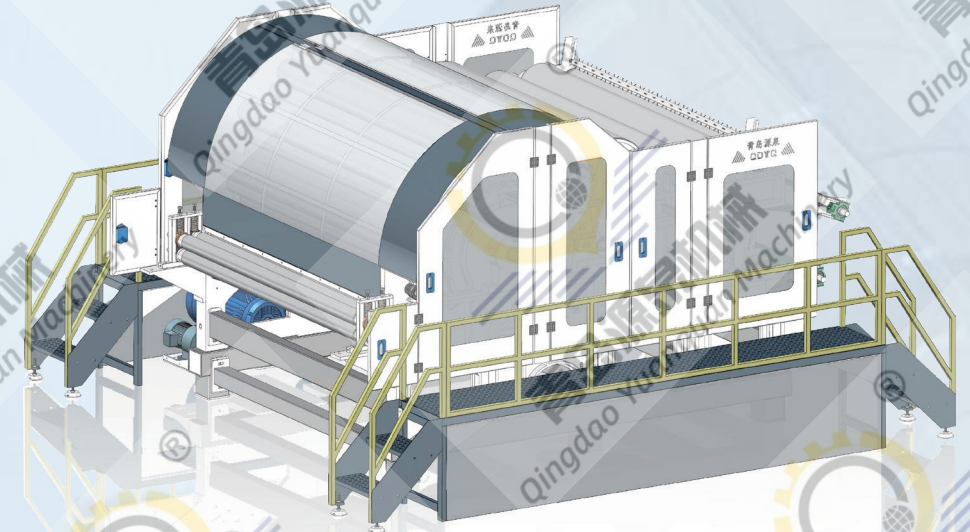

## 产品介绍

### PRODUCT INTRODUCTION

The structure of this machine is four feeding rollers, single cylinder and double doffer, which is suitable for polyester, polypropylene and other chemical fibers, also good for carding and netting some natural fibers (sheep wool, alpaca fiber and others). The machine body is made from cast iron with stable structure, sheet metal cover is processed by laser cutting and NC bending which is beautiful and generous. The cover can be lifted and lowered through the air cylinder, which is convenient and safe.

本机采用四罗拉喂入结构，适应涤纶、丙纶等化学纤维也适应部分天然纤维的梳理成网。铸铁机架圆墙板，结构稳定；钣金罩壳激光下料数控折弯，采用封闭式防护罩，有机玻璃视窗，美观大方，罩壳气缸升降，方便安全。

## 产品细节

### PRODUCT DETAILS



## 主要规格及参数

### MAIN SPECIFICATIONS AND PARAMETERS

型号 Model	工作幅宽 Working Width mm	产量 Output kg/h	外形尺寸 Dimension L×W×H mm			重量 Weight kg	功率 Power				
							锡林电机 Cylinder Motor	道夫电机 Doffer Motor	喂入电机 Feeding Motor	工作辊电机 Working Roller Motor	吸边风机 Side Suction Motor
YQ-1850-DSL	1850	100-400	3500	2750	2000	About 6000	18.5	3.7	1.5	2.2	4
YQ-2000-DSL	2000	100-400	3500	2900	2000	About 6500	22	3.7	1.5	2.2	4
YQ-2300-DSL	2300	150-500	3500	3200	2000	About 7000	22	3.7	2.2	2.2	4
YQ-2500-DSL	2500	150-550	3500	3400	2000	About 7500	22	3.7	2.2	2.2	4
YQ-2800-DSL	2800	200-600	3500	3700	2000	About 8000	30	3.7	2.2	2.2	4



# YQ-2300-SSL

YUAN QUAN MACHINERY

## 双锡林双道夫梳理机 Double Cylinder Double Doffer Carding Machine

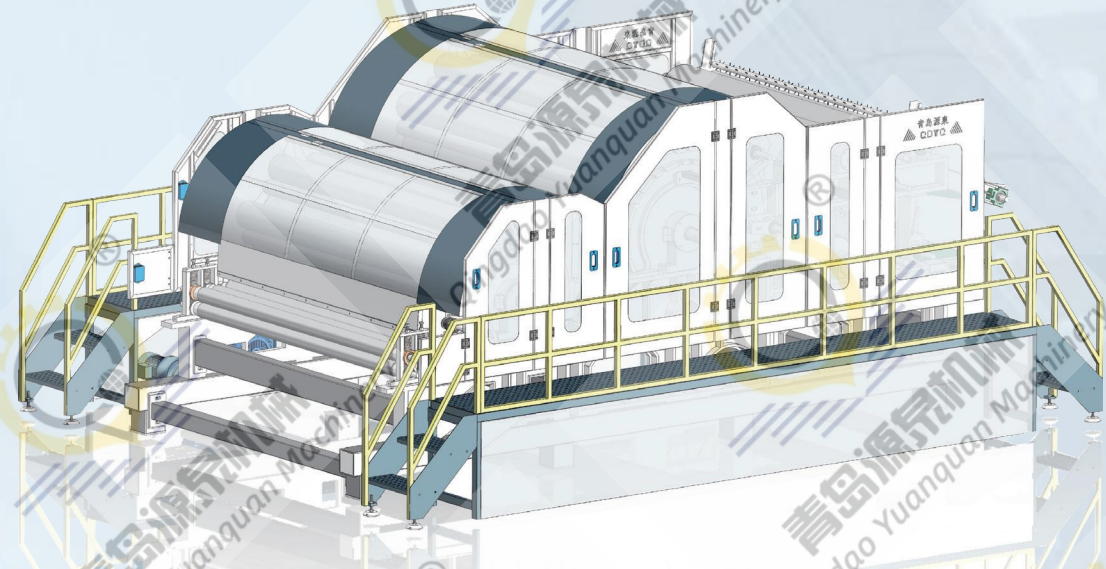

### 产品介绍

#### PRODUCT INTRODUCTION

This machine adopts double cylinders, double doffers, double random rollers, and double stripping rollers. It has the advantages of strong carding ability and high carding accuracy. The feeding rollers are paired into two upper and lower groups, with variable frequency speed regulation, and they are equipped with a metal detection device and a self-stop alarm function. And it is automatically fed into the inclined curtain of the cross lapping machine to reduce the labor intensity of the operator.

该机采用双锡林梳理，双道夫，双杂乱出棉，双罗拉剥棉，具有分梳能力强，梳理精度高等优点。喂入罗拉分上下两组配对，变频调速，并装有金属探测装置，具有自停报警功能。且自动送入铺网机斜帘，减轻操作工的劳动强度。

### 产品细节

#### PRODUCT DETAILS

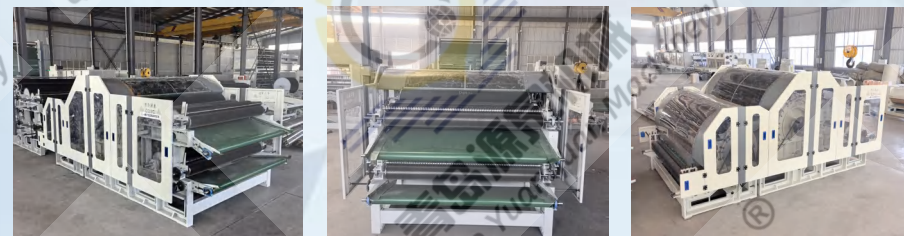
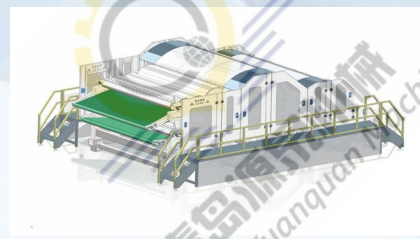
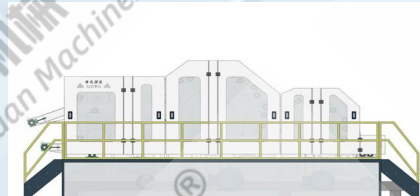

### 主要规格及参数

#### MAIN SPECIFICATIONS AND PARAMETERS

型号 Model	工作幅宽 Working Width mm	外形尺寸 Dimension L×W×H (mm)		重量 Wt kg	产量 Output kg/h	功率Power kw				
						锡林电机 Cylinder Motor	胸锡林电机 Chest Cylinder Motor	工作辊电机 Working roller Motor	吸边风机 Side suction Motor	道夫电机 Doffer Motor
YQ-1850-SSL	1850	5000	2600	2000	About 10000	18.5	11	2.2	4	3.7
YQ-2000-SSL	2000	5000	2800	2000	About 11000	22	11	2.2	4	3.7
YQ-2300-SSL	2300	5000	3100	2000	About 12000	22	11	2.2	4	3.7
YQ-2500-SSL	2500	5000	3300	2000	About 13000	22	15	2.2	4	3.7
YQ-2800-SSL	2800	5000	3600	2000	About 14000	30	15	2.2	4	3.7

# YQ-1020-SM

YUAN QUAN MACHINERY

## 梳棉机 Cotton Carding Machine

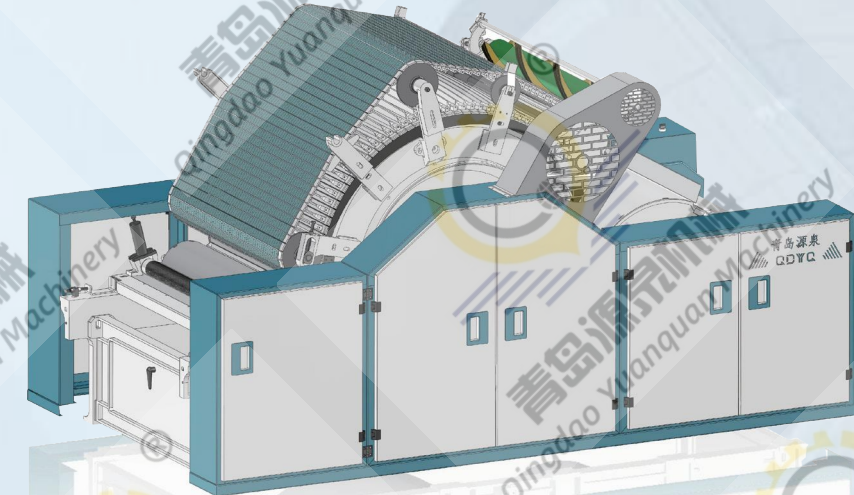

### 产品介绍

#### PRODUCT INTRODUCTION

This machine is suitable for pure chemical fiber spinning cotton or blended. It adopts a unique three-roller stripping method, adds a licker-in carding plate and the first four additional cover. Doffer adopts frequency control and has closed safety covers. The card clothing is made of high-quality metal card clothing and driven by synchronous belt, which is smooth and noiseless.

本机适用于纯棉化纤的纯纺或混纺，采用独有的三罗拉剥棉，增加刺辊分梳板，增设前四后二固定盖板。道夫采用变频调速，左右封闭式安全罩壳。采用优质的金属针布，同步带传动平稳无噪音。

### 产品细节

#### PRODUCT DETAILS

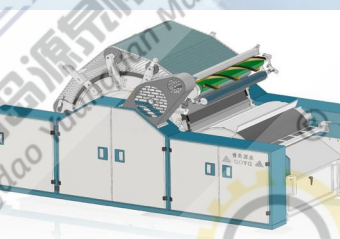
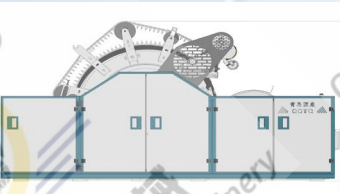
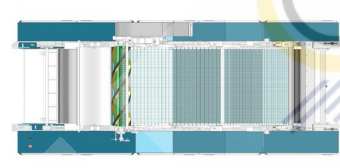

### 主要规格及参数

#### MAIN SPECIFICATIONS AND PARAMETERS

型号 Model	工作幅宽 Working Width mm	外形尺寸 Dimension L×W×H (mm)			机器重量 Weight kg	台时产量 Output kg/h	功率 Power kw		
							主电机 Main Motor	喂入电机 Feeding Motor	道夫电机 Doffer Motor
YQ-1000-SM	1000	3300	2000	1800	About 4000	2.2	1.5kw×2=3kw	0.75	
YQ-1500-SM	1500	3300	2500	1800	About 4000	2.2	1.5kw×2=3kw	0.75	



# YQ-2540-PW 交叉铺网机

YUAN QUAN MACHINERY Cross Lapper

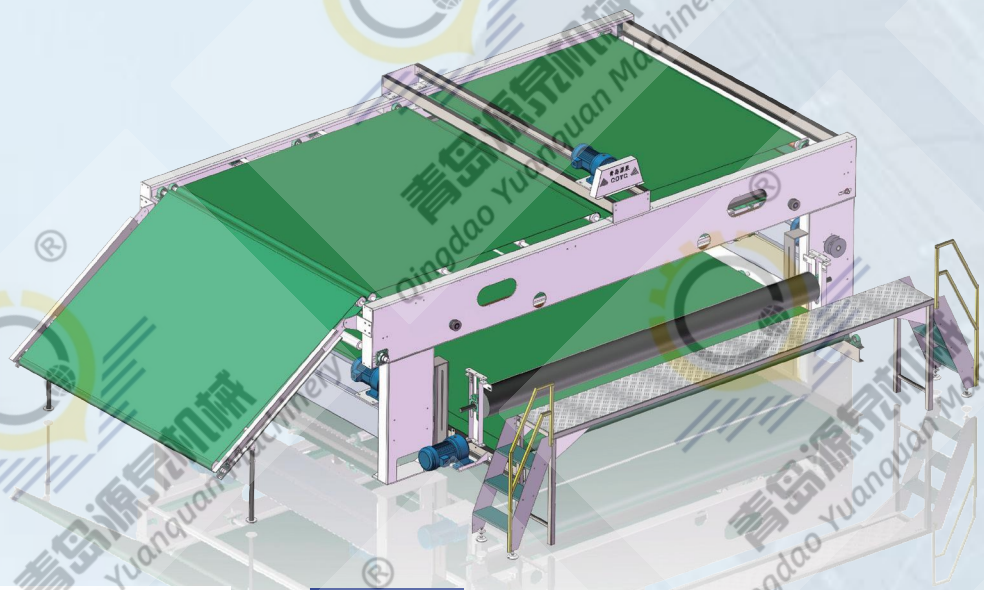

## 产品介绍

### PRODUCT INTRODUCTION

The fiber layer laid by this machine has a uniform texture. By changing the direction of the fiber layer, its width and layer thickness are evenly laid, and then transported to the next process after being pressurized. The differential speed compensation between each layer laying curtain can be adjusted to reduce the fiber layer stretch. The reciprocating steering can adjust the buffering force and rotation. (Can be customized)

本机铺设的棉网质地均匀。通过改变纤维网走向，均匀铺设纤维网宽度及层数厚度，加压后输送至下道工序。各铺网帘之间可调差速补偿减少纤维网拉伸，往复转向能调节缓冲力，回转平稳。（可根据客户需求定制）

## 产品细节

### PRODUCT DETAILS

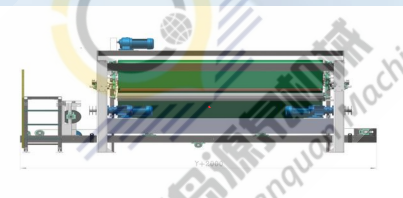
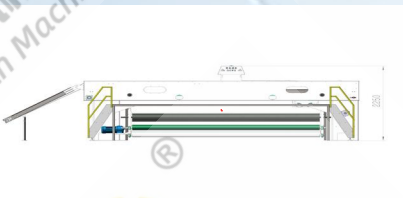
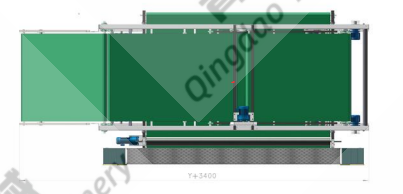

## 主要规格及参数

### MAIN SPECIFICATIONS AND PARAMETERS

型号 Model	工作幅宽 Working Width		外形尺寸 Dimension			重量 Weight	产量 Output	功率 Power		
	进帘宽度 Input	出帘宽度 Output						斜帘电机 Inclined Curtain Motor	往复电机 Reciprocating Motor	底帘传动电机 Bottom Curtain Drive Motor
			mm	mm	kg					
YQ-2040-PW	2000	4000	7400	4000	2250	About 3500	100-300	2.2	3.7	2.2
YQ-2240-PW	2200	4000	7400	4200	2250	About 4000	150-350	2.2	3.7	2.2
YQ-2760-PW	2700	6000	9400	4700	2250	About 5000	150-500	2.2	3.7	2.2

# YQ-3800-JCWR 夹持喂入机

YUAN QUAN MACHINERY Clamping Feeding Machine

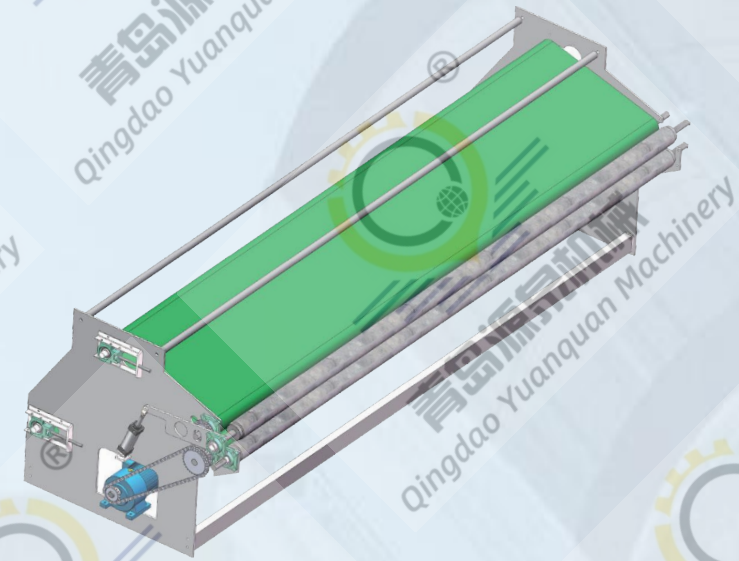

## 产品介绍

### PRODUCT INTRODUCTION

Mainly used in pre-needle punching machine web feeding, compressing fiber web thickness and excessive use in pre-needle punching machines or other equipment.

主要用于预针刺机送料、压缩纤维网厚度以及在预针刺机或其他设备中使用。

## 产品细节

### PRODUCT DETAILS

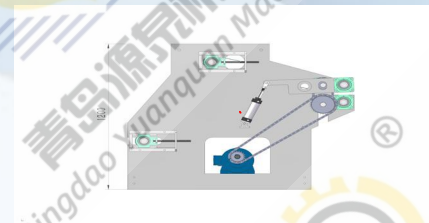
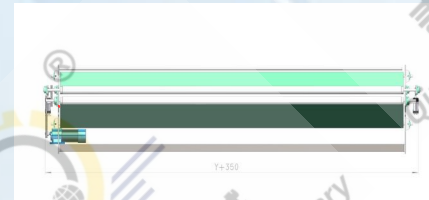
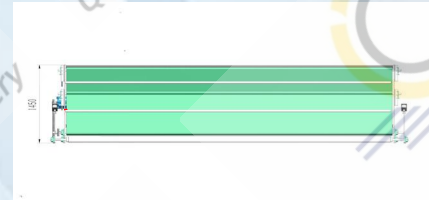

## 主要规格及参数

机器宽度: 3800mm  
克重: ≤3000g/m<sup>2</sup>  
速度: 0.6-8m/min  
功率: 2.2-5.5kw

## MAIN SPECIFICATIONS AND PARAMETERS

Working width: 3800mm  
Web weight: ≤3000g/m<sup>2</sup>  
Speed: 0.6-8m/min  
Power: 2.2-5.5kw



# YQ-3800-ZC 针刺机

YUAN QUAN MACHINERY Needle Loom

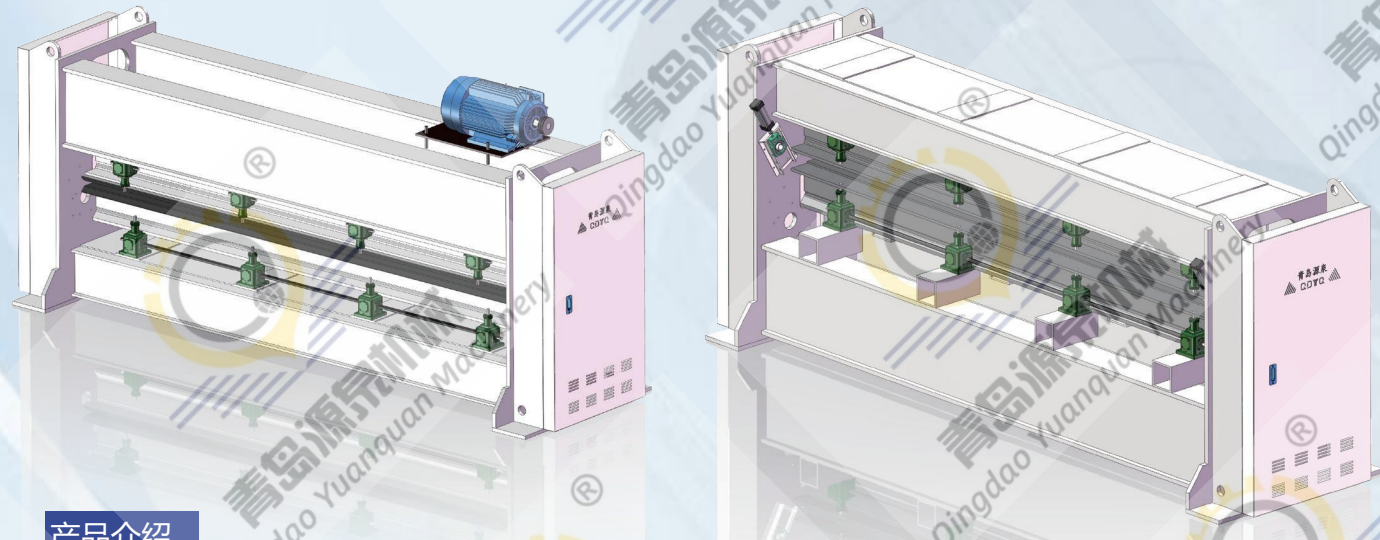

## 产品介绍

PRODUCT INTRODUCTION

This machine mainly produces non-woven materials such as needle felt, asphalt felt base material, geotextile, carpet and so on. The machine adopts dynamic balance structure, centralized oil supply, and it is equipped with an oil shortage alarm indicator. The bulkiness and thickness of the fiber web after needle punching can meet the quality requirements of non-woven felt. (Can be customized according to customers' needs.)

该机器主要适用于生产针刺毡、沥青毡基材、土工布、地毯等无纺材料。该机采用动力学平衡结构，集中供油，配有缺油报警指示器。经针刺机针刺后的纤网，蓬松度和厚度均能满足无纺毡的质量要求。(可根据客户需求定制)

## 产品细节

PRODUCT DETAILS



## 主要规格及参数

工作幅宽: 1800mm-6000mm或者定制  
 单板布针密度: 3000-7000 枚/米  
 双板布针密度: 6000-6200 枚/米  
 功率: 9-25 kw  
 出布速度: 0.6-8m/min  
 针刺频率: 约400-700 次/分钟  
 针刺行程: 30-65mm

## MAIN SPECIFICATIONS AND PARAMETERS

Working width: 1800mm-6000mm or customized  
 Single Needle density: 3000-7000 PCS/Meter  
 Double Needle density: 6000-6200 PCS/Meter  
 Power: 9-25 kw  
 Output speed: 0.6-8m/min  
 Needle frequency: About 400-700 times/min  
 Needling Stroke: 30-65mm

# YQ-3560-DHX 单层烘箱

YUAN QUAN MACHINERY Oven With Single Layer

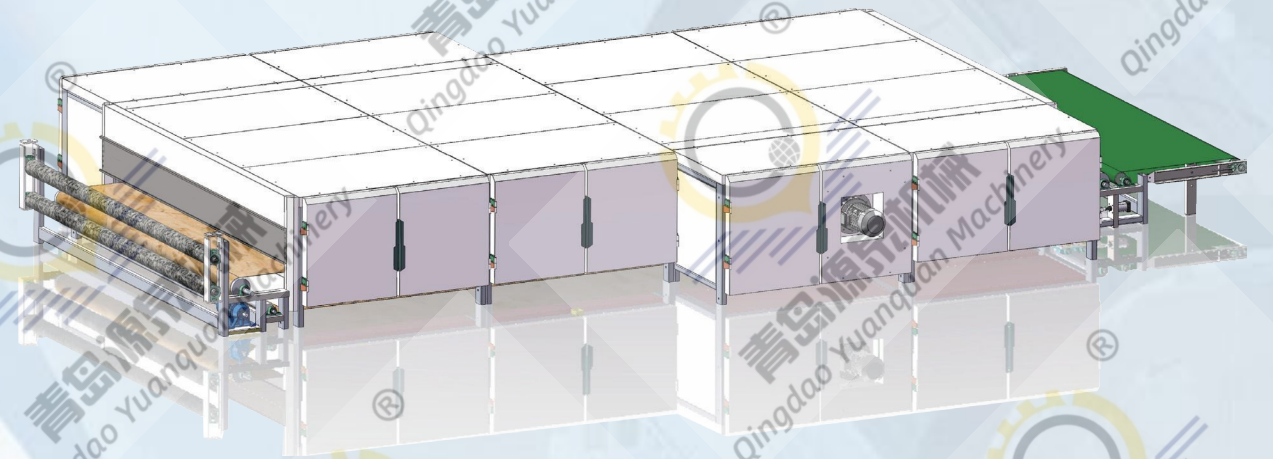

## 产品介绍

PRODUCT INTRODUCTION

This machine uses hot air penetration to melt low-melting point fibers and thermally bond the fiber layers coming out of the cross lapping machine. It can be heated by two burners or electric heating devices. It is used for soft wadding products such as quilt, clothing, bedding, furniture products, etc. (Can be customized)

本机是利用热风渗透将低熔点纤维熔化，并将交叉铺网/铺网机出来的纤维层热粘合的设备，可采用两个燃烧器或电加热装置加热，用于被子等软棉制品、服装、床上用品、家具产品等。(可根据客户需求定制)

## 产品细节

PRODUCT DETAILS

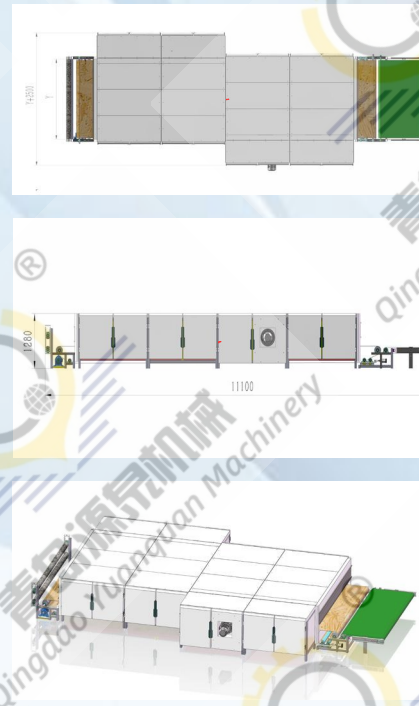

## 主要规格及参数

MAIN SPECIFICATIONS AND PARAMETERS

型号 Model	工作幅宽 Working Width	箱体尺寸 Main Oven Body			烘烤层高度 Height of Heating Layer	重量 Weight	功率 Power		
		mm	mm	mm			kg	kw	kw
YQ-3560-DHX	3200-4500 Or customized	11100	5700	1280	350mm Or customized	About 5000	2.2	2×5.5kw=11kw	2×130kw=260kw
YQ-3580-DHX	3200-4700 Or customized	11100	6080	1280	350mm Or customized	About 5500	2.2	2×5.5kw=11kw	2×130kw=260kw



# YQ-3850-SHX 节能式三层烘箱

YUAN QUAN MACHINERY Energy Saving Type Three Layers Oven

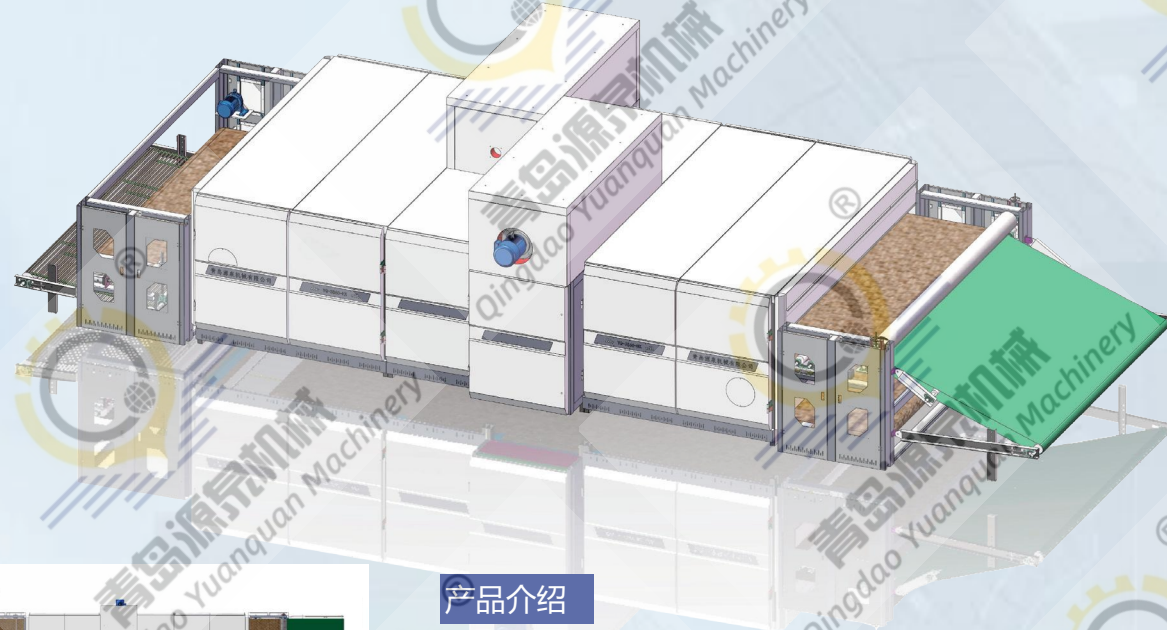

## 产品介绍

### PRODUCT INTRODUCTION

This machine is mainly for producing soft wadding product, like glue-free product, silk-like product, etc., which is widely used in clothing, embroidery, bedding, furniture, travel products, etc. As a dual-purpose energy-saving oven, it can be heated by burner (one set) or electric heating. The circulating fan penetrates the hot air through the air duct and blows it up and down to achieve the maximum energy-saving. Moreover, the three-layer mesh belt is separate transmission, each main drive adopts frequency conversion control. (Can be customized)

通过本机作用可生产无胶棉、仿丝棉等，产品广泛应用于服装、绣品、床上用品、家私旅游产品等。该机器可采用1台燃烧器加热或电加热，循环风机将热风经风道穿透对流，上吸下吸，从而达到最大节能效果，而且三层网带单独传动，各主传动采用变频控制。（可根据客户需求定制）

## 产品细节

### PRODUCT DETAILS

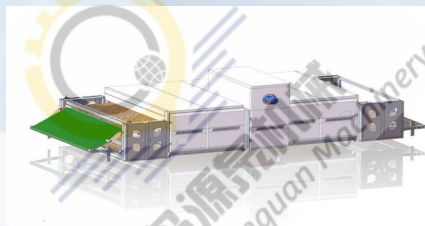
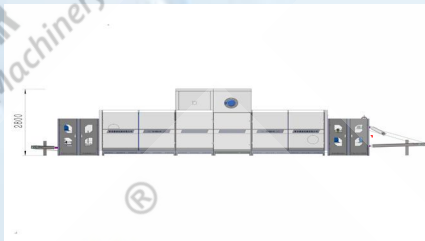
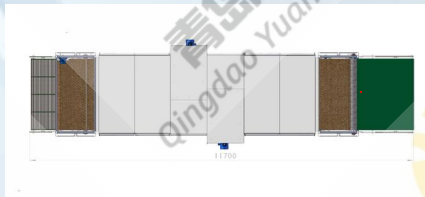

## 主要规格及参数

### MAIN SPECIFICATIONS AND PARAMETERS

型号 Model	工作幅宽 Working Width mm	箱体尺寸（不含前后帘） Oven body size (not including the front and rear curtains) mm		重量 Wt kg	加热方式 Heating Mode /	功率 Power kw		
						传电动机 Motor of Driving	风机电机 Motor of Fan	加热管 Heating Tubes
YQ-2850-SHX	2850	11700	3850	2800	（天然气加热，液化气，柴油加热活电加热） Natural gas, liquefied gas, diesel heating or electric heating	2.2kw×3=6.6kw	5.5	160kw
YQ-3850-SHX	3850	11700	4850	2800		2.2kw×3=6.6kw	5.5	160kw
YQ-4250-SHX	4250	11700	5250	2800		2.2kw×3=6.6kw	7.5	160kw
YQ-4860-SHX	4860	11700	5860	2800		2.2kw×3=6.6kw	7.5	160kw

# YQ-3090-YHX 硬质棉烘箱

YUAN QUAN MACHINERY Oven For Hard Wadding

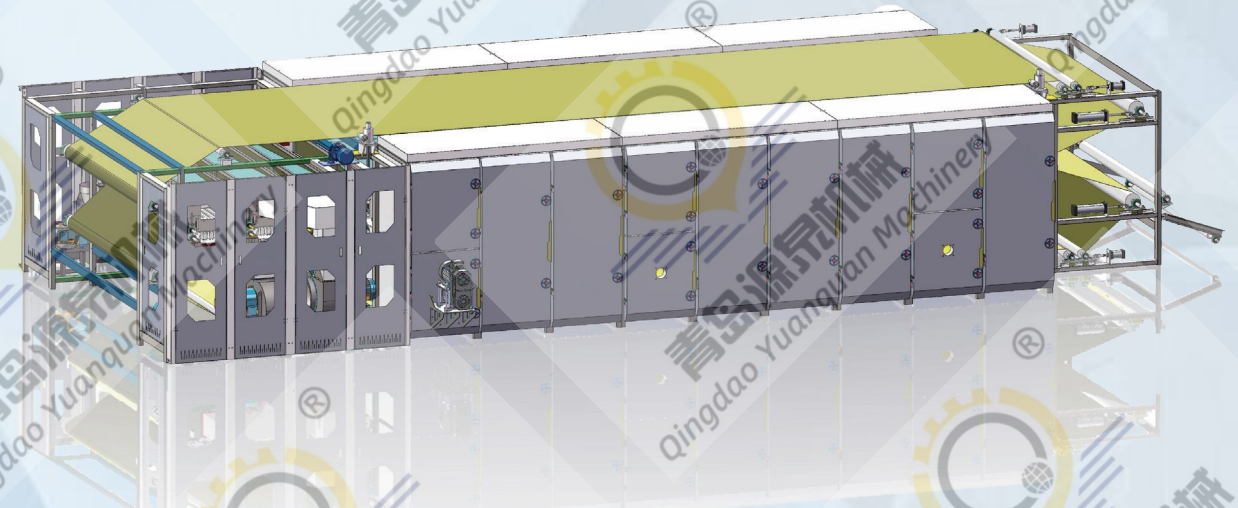

## 产品介绍

### PRODUCT INTRODUCTION

This oven can be used to produce hard wadding product, like glue-free product, silk-like product, wool insulation, wool quilts, etc., which is widely used in clothing, embroidery, bedding, furniture, travel products, etc. The oven can be heated by three burners, and three circulating fans will penetrate the hot air through the air duct and blow it against each other to achieve the maximum hot air. The two-layer mesh belt is driven in an integrated manner and adopts frequency conversion control. (Can be customized)

该烘箱可用于生产硬质棉、无胶棉、仿丝棉、直立棉、羊毛保温层、羊毛被等，该产品广泛应用于服装、绣品、床上用品、家私、旅游产品等。该烘箱可采用3台燃烧器加热，3台循环风机将热风经风道穿透对流，对吹，从而达到最大热风效果且两层网带一体传动，采用变频控制。（可根据客户需求定制）

## 产品细节

### PRODUCT DETAILS

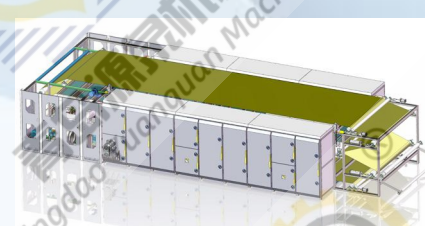
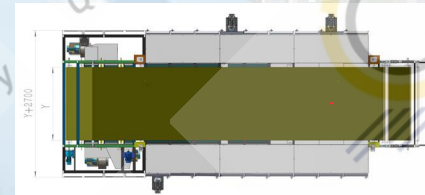

## 主要规格及参数

### MAIN SPECIFICATIONS AND PARAMETERS

型号 Model	工作幅宽 Working Width mm	箱体尺寸（不含前后帘） Oven Dimension(not including the front and rear curtains) mm			设备重量 Weight kg	功率 Power kw		
						传电动机 Transmission Motor	热风机电机 Hot Air Blower Motor	冷风机电机 Cooler Fan Motor
YQ-3060-YHX	2500	13500	5200	2500	About 17000	1×3kw=3kw	3×7.5kw=22.5kw	4×5.5kw=21.5kw
YQ-3090-YHX	3000	13500	5700	2500	About 18000	1×3kw=3kw	3×11kw=33kw	4×5.5kw=21.5kw
YQ-30120-YHX	3500	13500	6200	2500	About 20000	1×3kw=3kw	3×22kw=66kw	4×5.5kw=21.5kw



# YQ-60120-PHX 喷胶棉烘箱

Oven For Spray-Bonded Product

YUAN QUAN MACHINERY

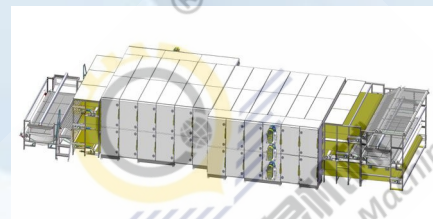
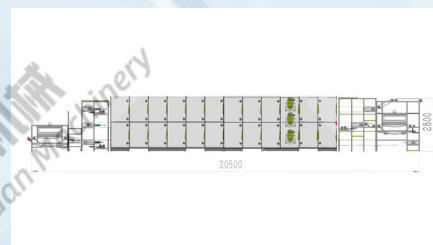
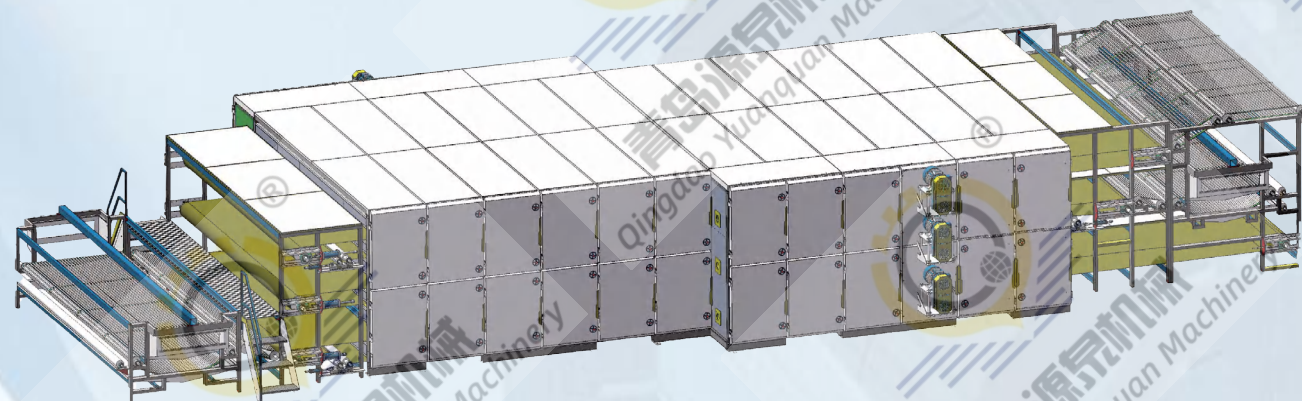

## 产品介绍

### PRODUCT INTRODUCTION

This machine is mainly used to produce high-elastic spray-bonded product, imitation silk product, etc. The oven uses natural gas heating, and the three-layer mesh belt is driven independently to facilitate left and right temperature adjustment. The temperature insulation design of each layer allows the temperature of each layer to be adjusted at will. It adopts a square tube frame, the whole machine can be frequency control, and the upper, middle and lower layers of the conveyor are all made of Teflon mesh belts. (Can be customized)

本机主要用于生产高弹喷胶棉、仿丝棉等。该烘箱采用天然气加热方式加热，三层网带单独传动，方便左右温度调节。烘箱每层隔热设计，使每层温度可随意调节。采用方管框架，整机变频调速且输送带中、下三层均采用特氟龙网带。（可根据客户需求定制）

## 产品细节

### PRODUCT DETAILS



## 主要规格及参数

### MAIN SPECIFICATIONS AND PARAMETERS

型号 Model	工作幅宽 Working Width mm	外形尺寸 Dimension L×W×H (mm)			机器重量 Wt kg	功率 Power kw		
		L	W	H		传动电机 Driving Motor	风机 Fan	喷胶电机 Glue Spraying
YQ-60120-PHX	4000mm or customized	20500	6300-8300	2800	About 26000-32000	3.7kw×3=11.1kw	11kw×6=66kw	2.2kw×2=4.4kw

# YQ-3800-TG 烫光机

YUAN QUAN MACHINERY Ironing Machine

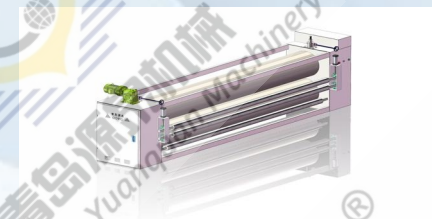
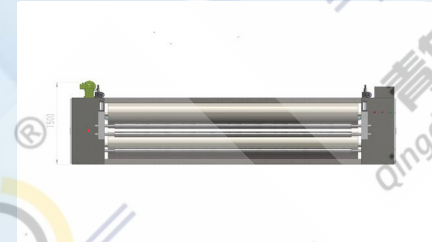
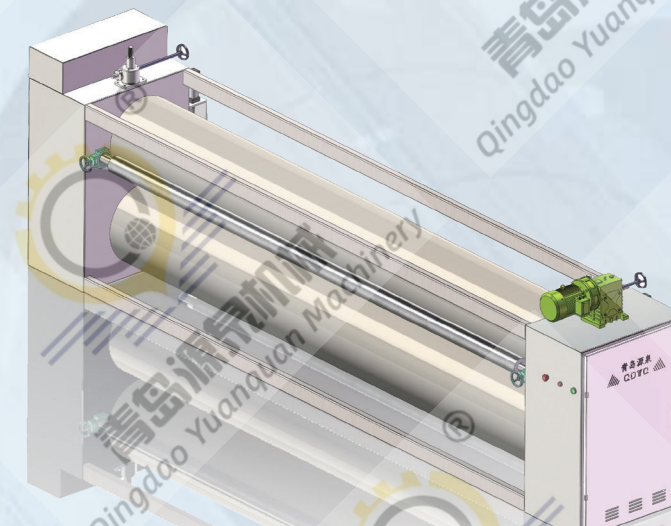
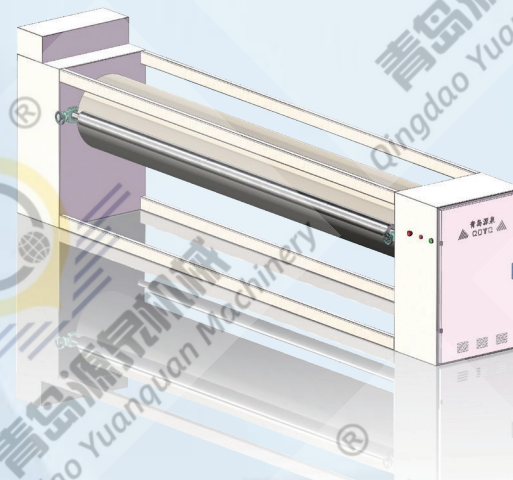

## 产品介绍

### PRODUCT INTRODUCTION

Usage characteristics: Suitable for surface heat treatment of non-woven fabrics to achieve the required thickness and smoothness of the product. Electric heating is used, and each heating roller is controlled by an independent motor. It has two structural forms: single-roller pre-ironing and double-roller main ironing. It has automatic temperature control and digital temperature display. Ironing machines (calenders, hot rolling machines) are mainly used to iron the surface of various velvet fabrics such as acrylic blankets, artificial fur, woolen, fine imitation plush and other products. The fabrics after ironing treatment The surface is soft and fluffy, and the pile is straight and bright, comparable to natural fabrics

用途特点:适用于无纺布表面热处理, 达到产品所需的厚度及光洁度。采用电加热, 且每根加热辊单独电机控制, 单辊预烫光和双辊主烫光两种结构形式, 自动控温, 数显温度。烫光机(压光机、热轧机)主要用于各种绒类织物如:晴纶毛毯、人造毛皮、呢绒、精仿毛毯等产品的后整理表面烫光, 经烫光处理后的织物表面蓬松柔软, 绒毛顺直光亮, 可与天然织物相媲美。

## 产品细节

### PRODUCT DETAILS



## 主要规格及参数

### MAIN SPECIFICATIONS AND PARAMETERS

型号 Model	工作幅宽 Working Width mm	尺寸 Dimensions L×W×H (mm)			设备重量 Weight kg	罗拉直径 Roller Diameter mm	罗拉数量 Number of Rollers groups	加热方式 Heating Method	加热管数量 Number of Heating Tubes	功率 Power
		L	W	H						
YQ-3800-YT	3800	4850	800	1400	About 3000	570	1	Electric Heating Tubes 电加热管	9	5.5kw×9=49.5kw
YQ-3800-ZT	3800	4850	950	1500	About 3000	570	2	Electric Heating Tubes 电加热管	9	4.0kw×9=36kw



# YQ-3800-LF 冷风机

YUAN QUAN MACHINERY Air Cooler

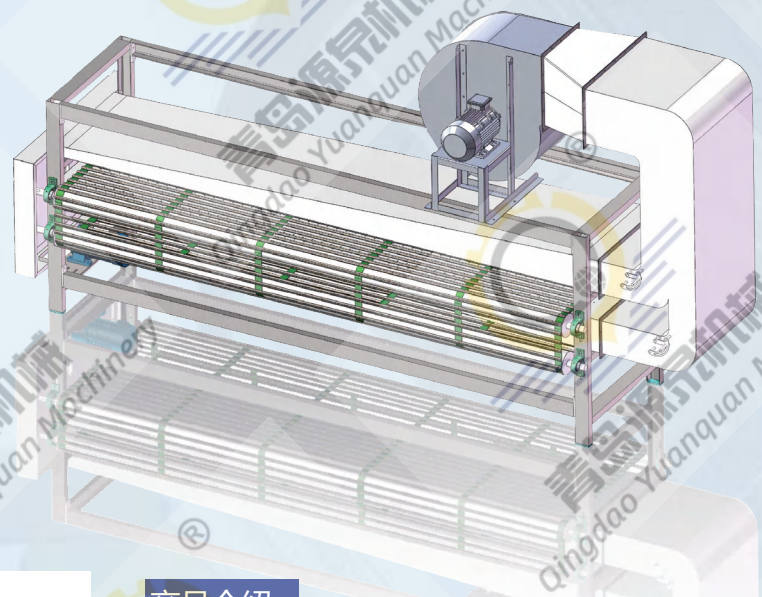

## 产品介绍

### PRODUCT INTRODUCTION

1. Purpose: To cool and shape glue spray wadding or wadding without glue (soft wadding)
2. The machine frame is made of profile steel;
3. The transmission adopts a wooden curtain and drum transmission, with a 1.5KW motor, controlled by Inverter;
4. Upward and downward blowing cooling method, with adjustable fixed height of the wooden curtain;
5. Cooling fan 4KW, controlled by Inverter

1. 将喷胶棉或无胶棉冷却及定型
2. 机架采用型钢制作;
3. 传动采用木帘加滚筒传动, 1.5KW 电机变频调速;
4. 上吹下吹式冷却方式, 木帘固定高度可上下调节;
5. 冷却风机 4KW 变频调速。

## 产品细节

### PRODUCT DETAILS



## 主要规格及参数

工作幅宽: 3800mm或定制  
 机器重量: 约一吨  
 冷却方式: 强制风冷, 对吹式  
 功率: 4.75kw

## MAIN SPECIFICATIONS AND PARAMETERS

Working width: 3800mm or customized  
 Machine weight: About 1000kg  
 Cooling method: forced air cooling, opposite blowing  
 Power: 4.75kw

# YQ-3600-SJQB 收卷切边机

YUAN QUAN MACHINERY Winding And Cutting Machine

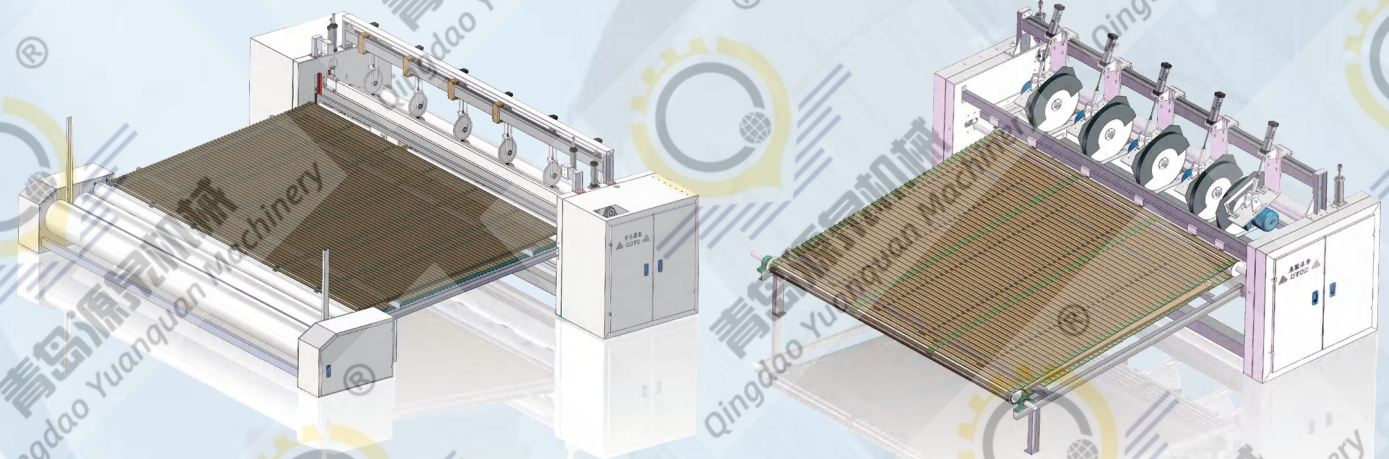

## 产品介绍

### PRODUCT INTRODUCTION

该机器采用飞刀切割或电热丝方式横切, 并配有四把纵切切刀, 其主要用于将喷胶棉、无胶棉、硬质棉等进行切边、收卷并裁剪成符合要求的尺寸规格。本机具有计数功能、跟踪横切功能。

The cutting mode of this machine is by fly-cutter or electric heating wire method cross cutting, and it is equipped with four longitudinal cutting knives. It is mainly used for cutting the side of glue spraying wadding, soft wadding, hard wadding or other non woven fabric and winding to wadding roll etc. Meanwhile, this machine can also cut the glue spraying wadding into different sizes according to the requirements of customers. This machine has the function of counting and tracking crosscutting.

## 产品细节

### PRODUCT DETAILS

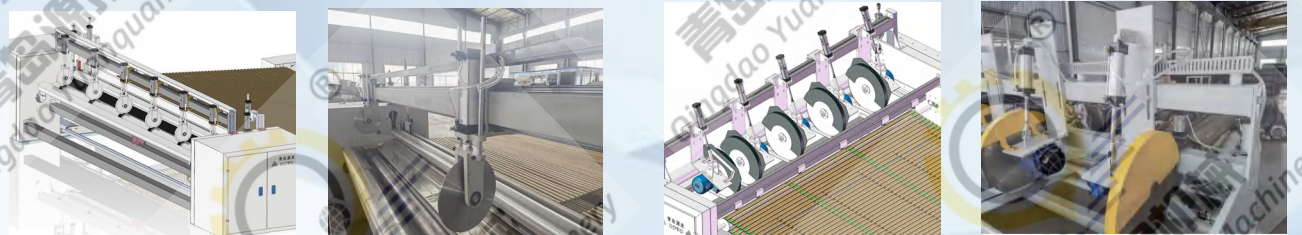

## 主要规格及参数

### MAIN SPECIFICATIONS AND PARAMETERS

型号 Model	工作幅宽 Working Width	外形尺寸 Dimension			走步速度 Working Speed	卷曲方式 Winding Mode	切割方式 Cutting Mode	升降方式 Lifting Mode
	mm	L	W	H (mm)	m/min	mm		
YQ-3600-SJQB	3600 or Customized	4700	4750	1500	3-15	Frictional Curling 摩擦卷曲	By Fly-Cutter Or Heating Wire Cutting 飞刀切割或电热丝切割	Cylinder Lifting 气缸升降
YQ-3000-QK	3000 or Customized	3500	3550	1900	3-15	无 No	By Fly-Cutter 飞刀切割	



# YQ-JMX-A

集棉箱  
Fiber Collection Box

## 产品介绍

PRODUCT INTRODUCTION

连续喂棉系统，是储棉供棉设备，能提高自动喂棉的均匀度。

The Fiber Collection Box feeding system is a cotton storage and supply equipment that can improve the uniformity of automatic cotton feeding.

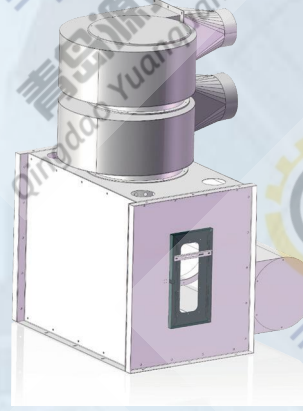

## 产品细节

PRODUCT DETAILS

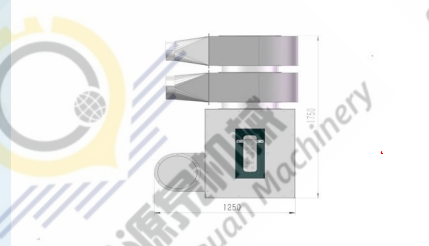
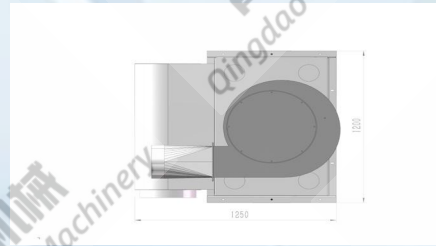

# YQ-JMX-B

开松用集棉箱  
Fiber Collection Box For Opening

## 产品介绍

PRODUCT INTRODUCTION

连续喂棉系统，是储棉供棉设备，能提高自动喂棉的均匀度，这台机械是开松机专用集棉箱。

The Fiber Collection Box feeding system is a fiber storage and supply equipment that can improve the uniformity of automatic fiber feeding. This machine is specially designed for opening machines.

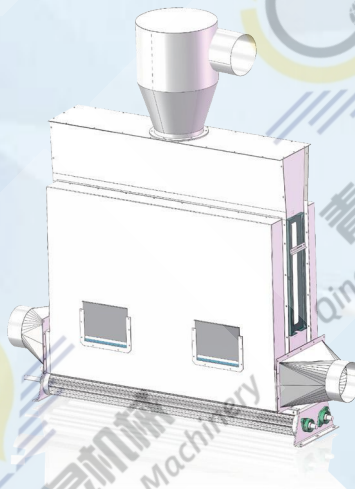

## 产品细节

PRODUCT DETAILS

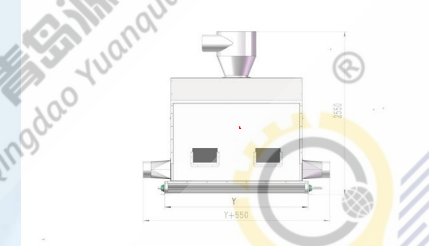
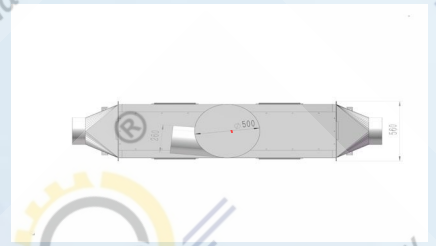

## 配套产品

# OTHER ACCESSORIES

Soft Wadding Roll Packing Machine

棉卷打包机

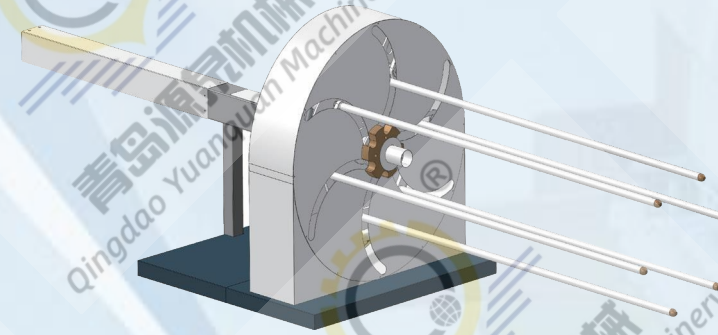

Soft Wadding Breaking & Filling Machine

拉断装套机

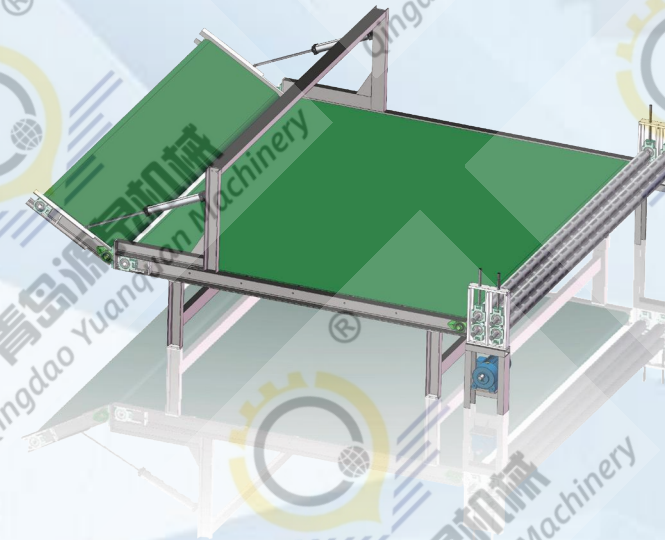

Metal Card Clothing Wrapping Machine  
金属针布包卷机

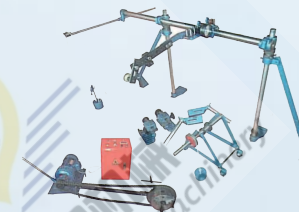

Licker-in Roller Wrapping And Grinding Machine  
刺辊包磨机

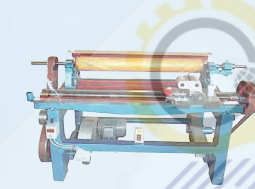

Slow Speed Driving Unit  
慢速传动装置



Metal Function Card Clothing Weldor  
金属针布焊接机



Auto Weighing  
自调匀整(电子称重)



Weighing Control(Belt Type)  
皮带秤



Metal (Fire) Detector  
金属(火)探除器

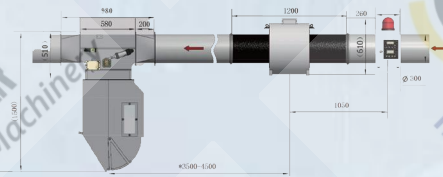

Magnet  
桥型磁铁





# 生产线系列 PRODUCTION LINE SERIES

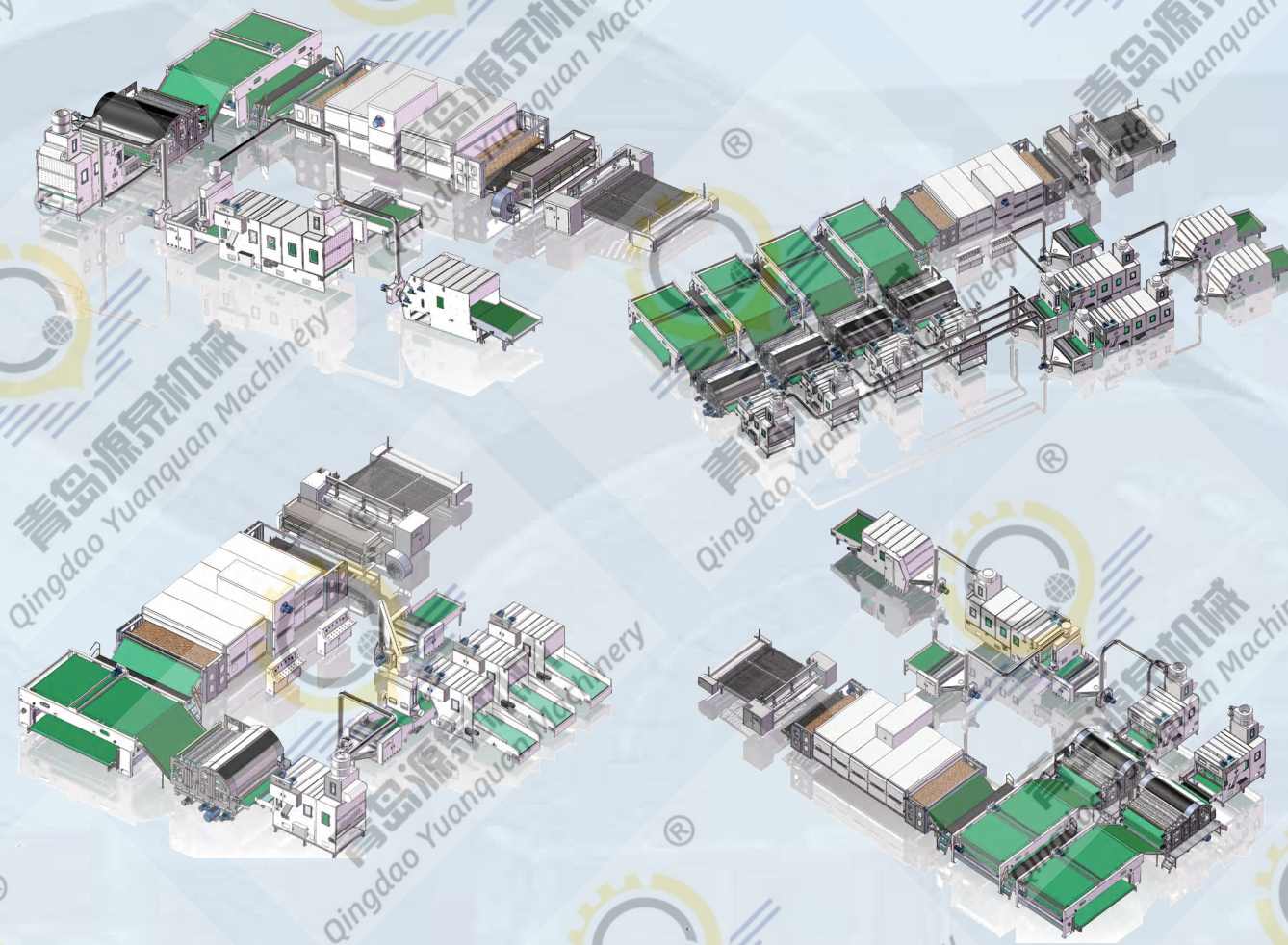
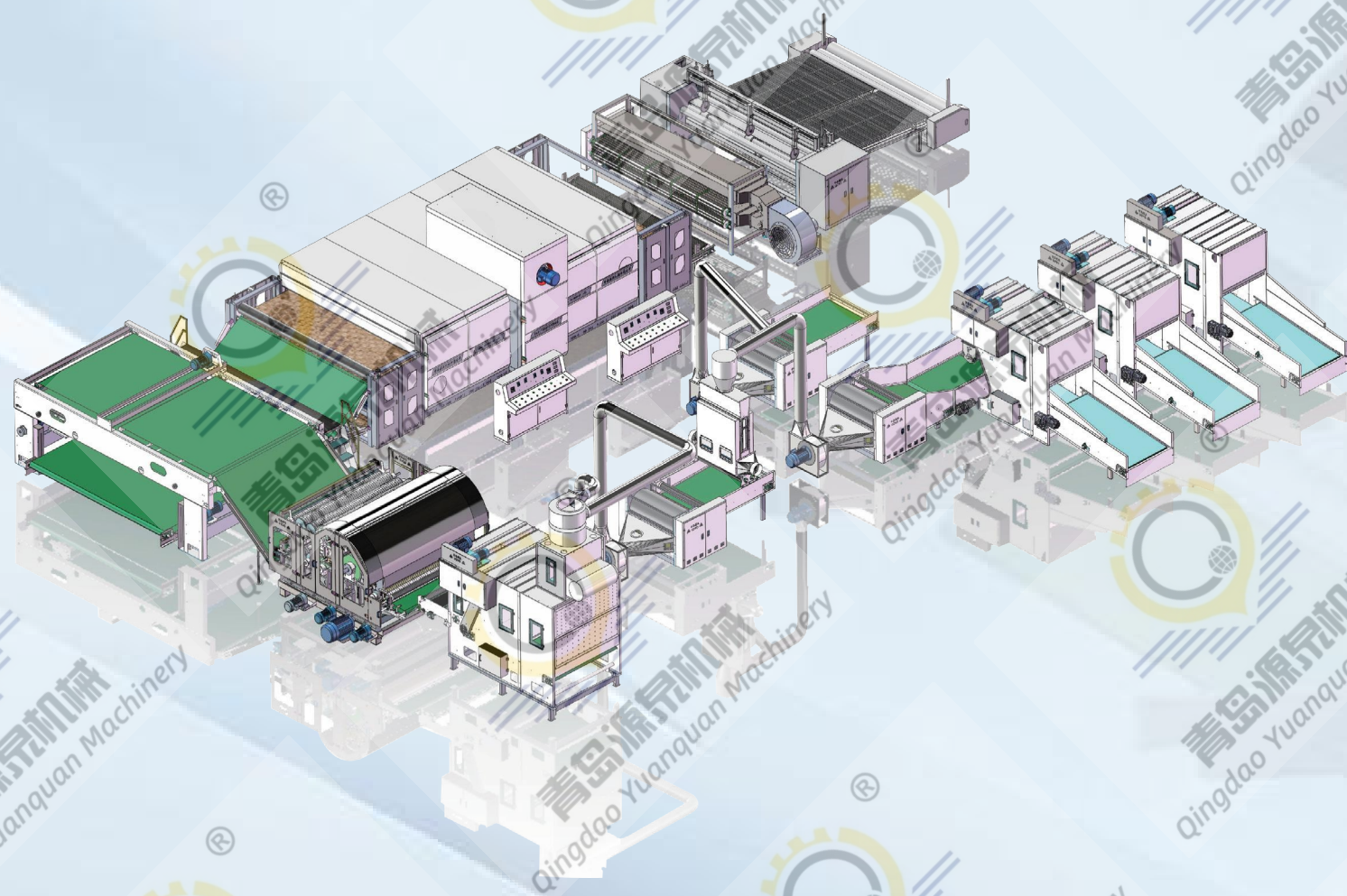

## 节能烘箱无胶绵生产线

### Energy Saving Type Soft wadding production line

该生产线在家纺制品行业非常受欢迎。无胶棉生产线主要用于生产无胶棉，广泛的用于被褥、服装填充棉，大棚保温被，电动车挡风被，吸音棉，初效空气过滤棉、沙发靠垫填充棉软棉和高档家用纺织材料，如被子、床垫、沙发等。该生产线可根据客户需求定制不同配置的生产线，如开包式无胶棉生产线，混料式无胶棉生产线等等。

This production line is very popular in the home textile products industry. It is mainly used to produce soft wadding product, which is widely used in quilts, clothing filling, greenhouse insulation quilts, electric vehicle windshield quilts, sound-absorbing product, primary air filter product, sofa cushion filling and high-end household products, such as quilts, mattresses, sofas, etc.

This production line can be customized with different types according to customers' requirements, such as bale opening type soft , mixing system, etc.





# 生产线系列 PRODUCTION LINE SERIES

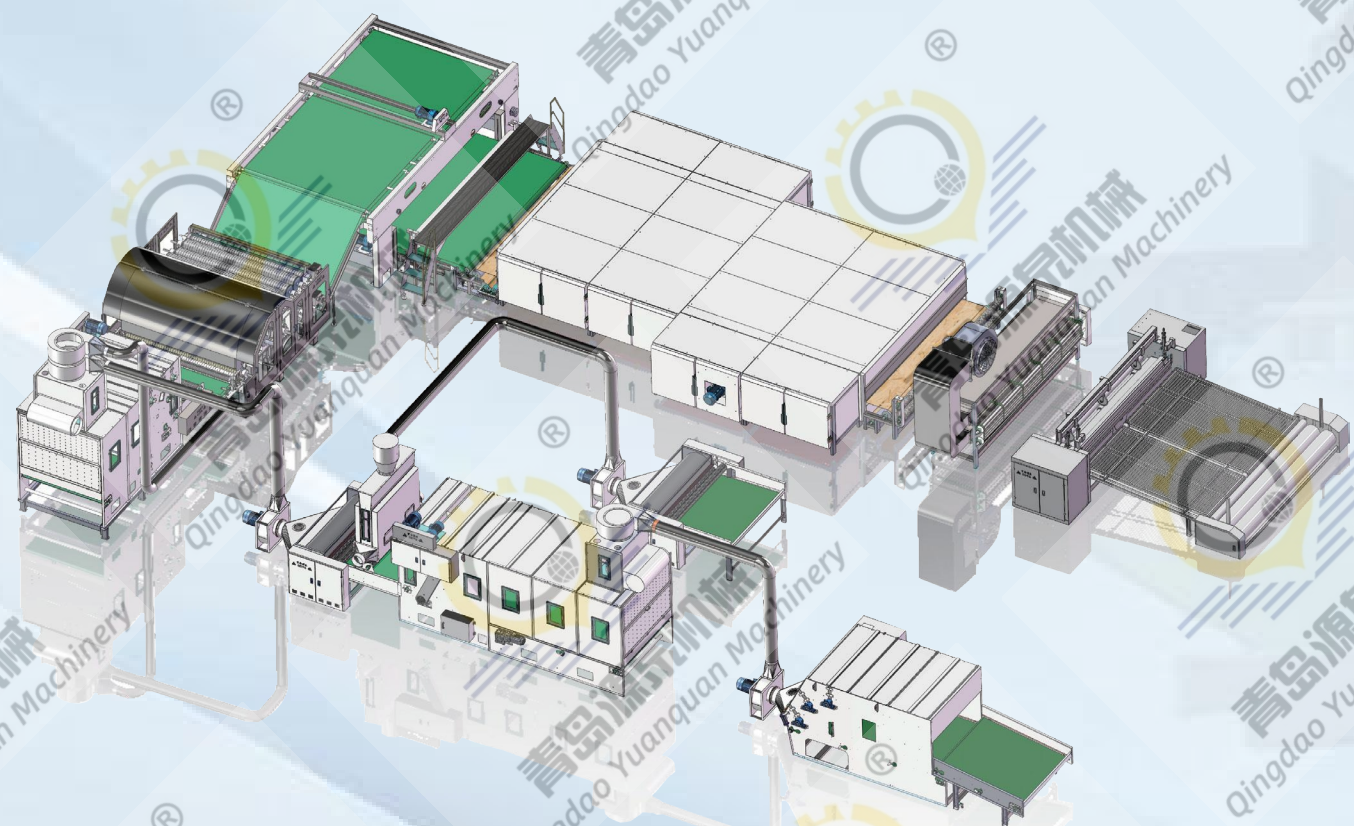

## 单层烘箱无胶棉生产线

### Soft Wadding Production Line With Signal Layer Oven

单层烘箱无胶棉生产线主要生产无胶棉，其广泛用于被子、服装填充棉等。该生产线可根据客户需求定制不同配置的生产线，如开包式无胶棉生产线，混料式无胶棉生产线等等。

Soft wadding production line with signal layer oven mainly produces soft wadding product, which is widely used in quilts, clothing filling, etc. This production line can be customized with different types according to customers' requirements, such as bale opening type soft , mixing system, etc.

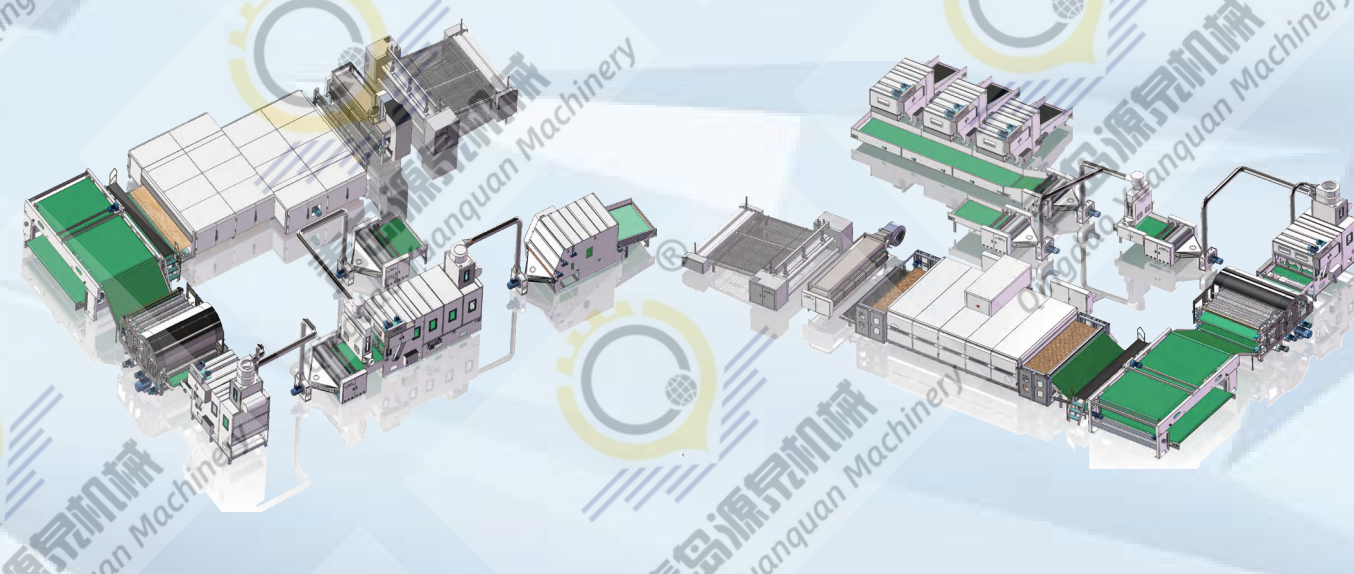
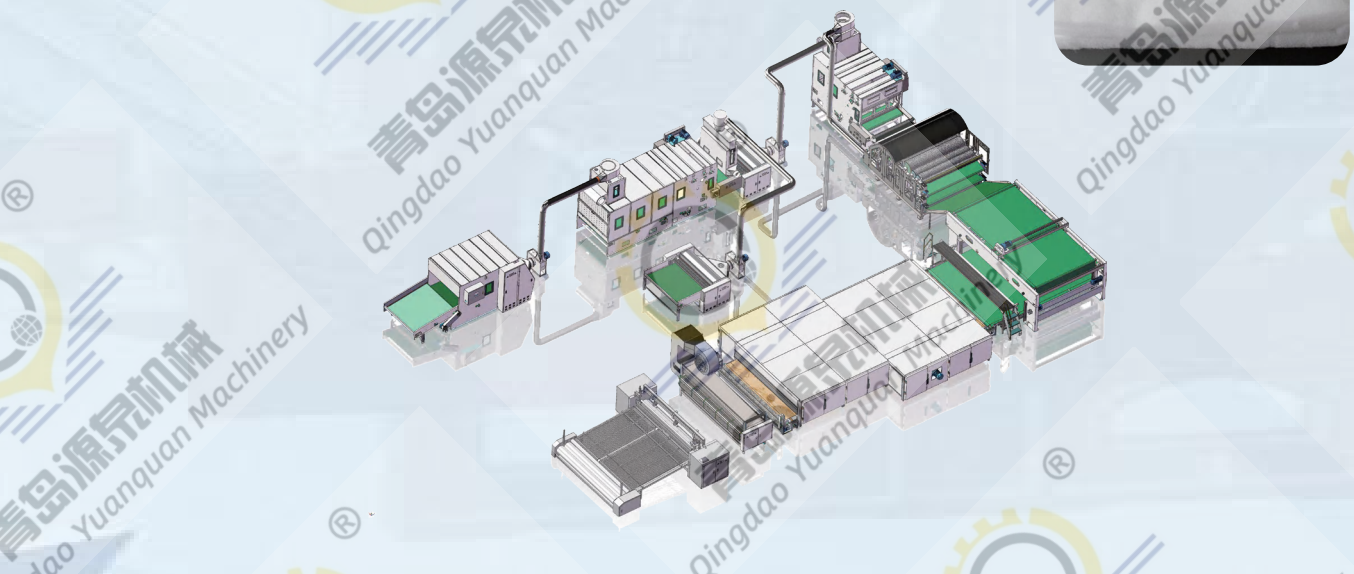
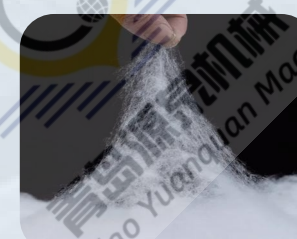
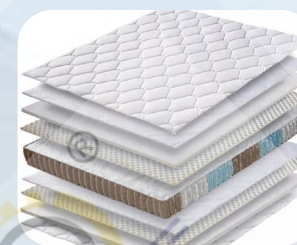
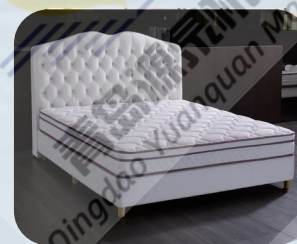



# 生产线系列 PRODUCTION LINE SERIES

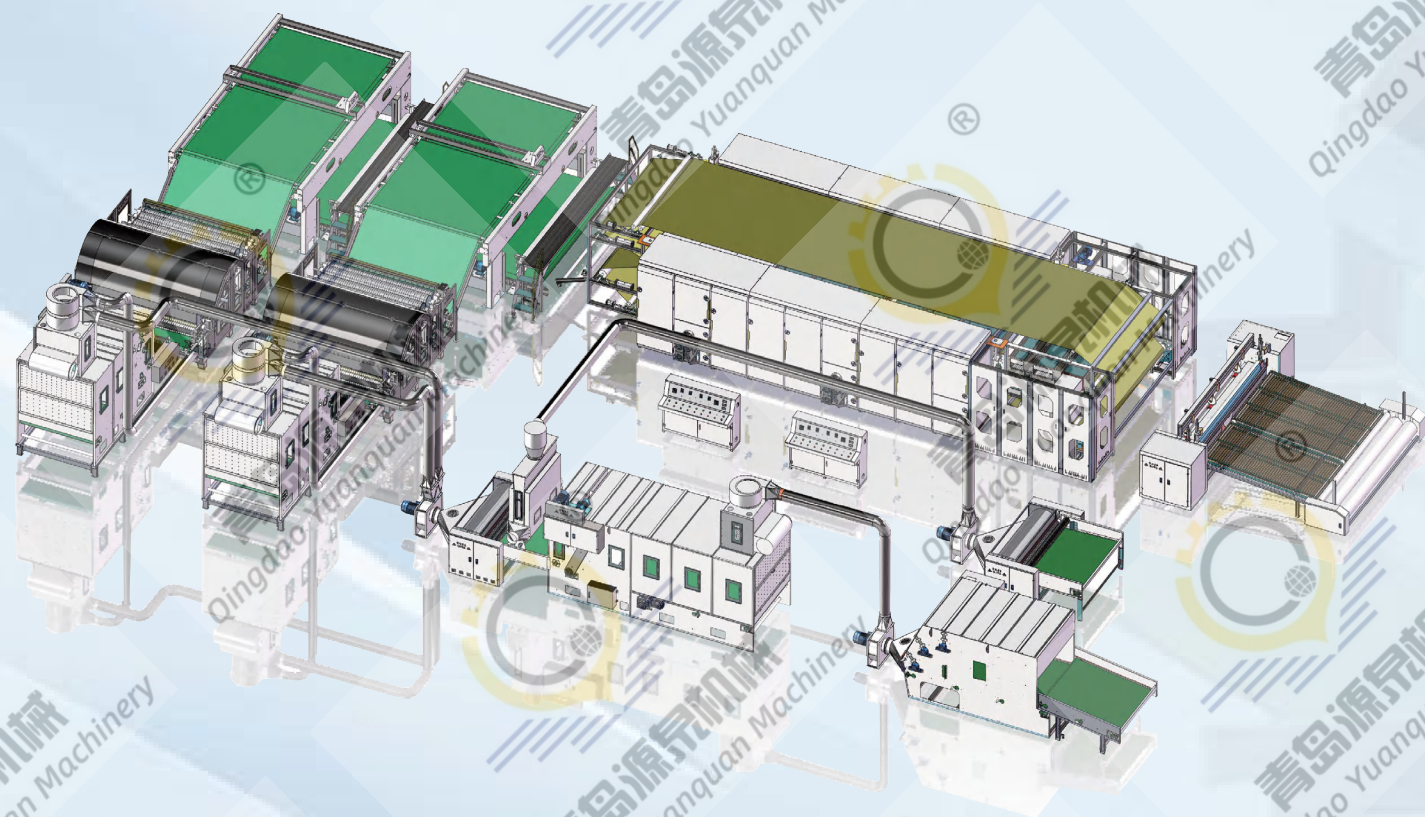

## 硬质棉生产线

### Thermal Bonded Hard Wadding Production Line

这种完整的无纺布生产线适用于几乎所有低熔点纤维的化纤。其成品广泛用于床垫、座垫、日式榻榻米、吸音材料、空气过滤材料等。

该生产线可根据客户需求定制不同配置的生产线，如双机头硬质棉生产线，双混双头硬质棉生产线等。

This kind of non woven production line is suitable for almost all chemical fibers with low melting point fiber. Its finished products are widely used for mattress, seat cushion, Japan style tatami, sound-absorbing materials, air filter materials, etc.

It can be customized with different types according to different requirements, such as double heads thermal bonded production line and two heads with two mixing machines thermal bonded production line.

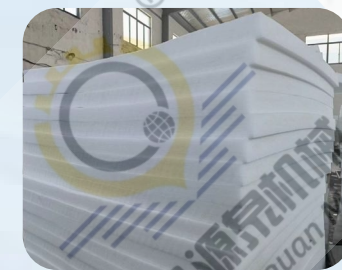
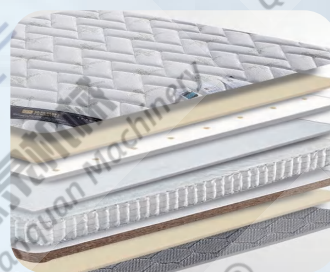



# 生产线系列 PRODUCTION LINE SERIES

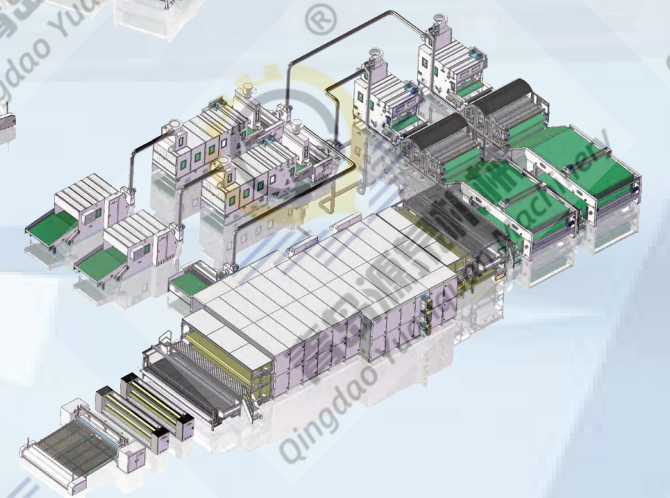
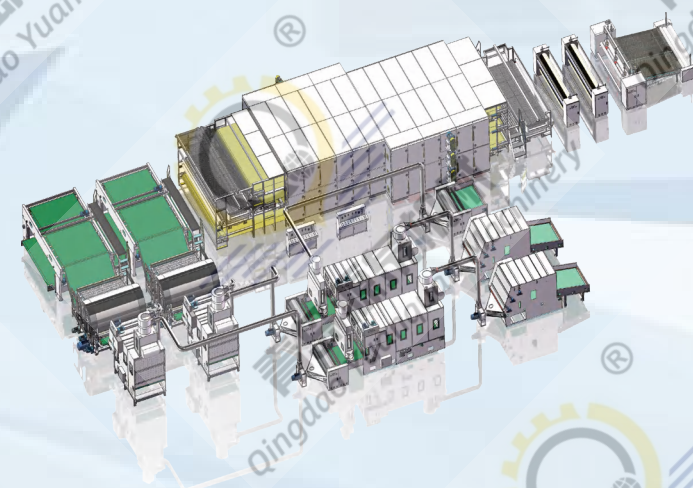
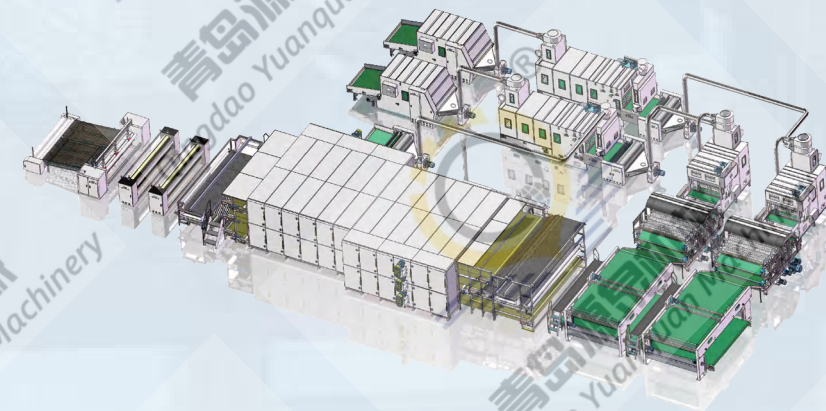
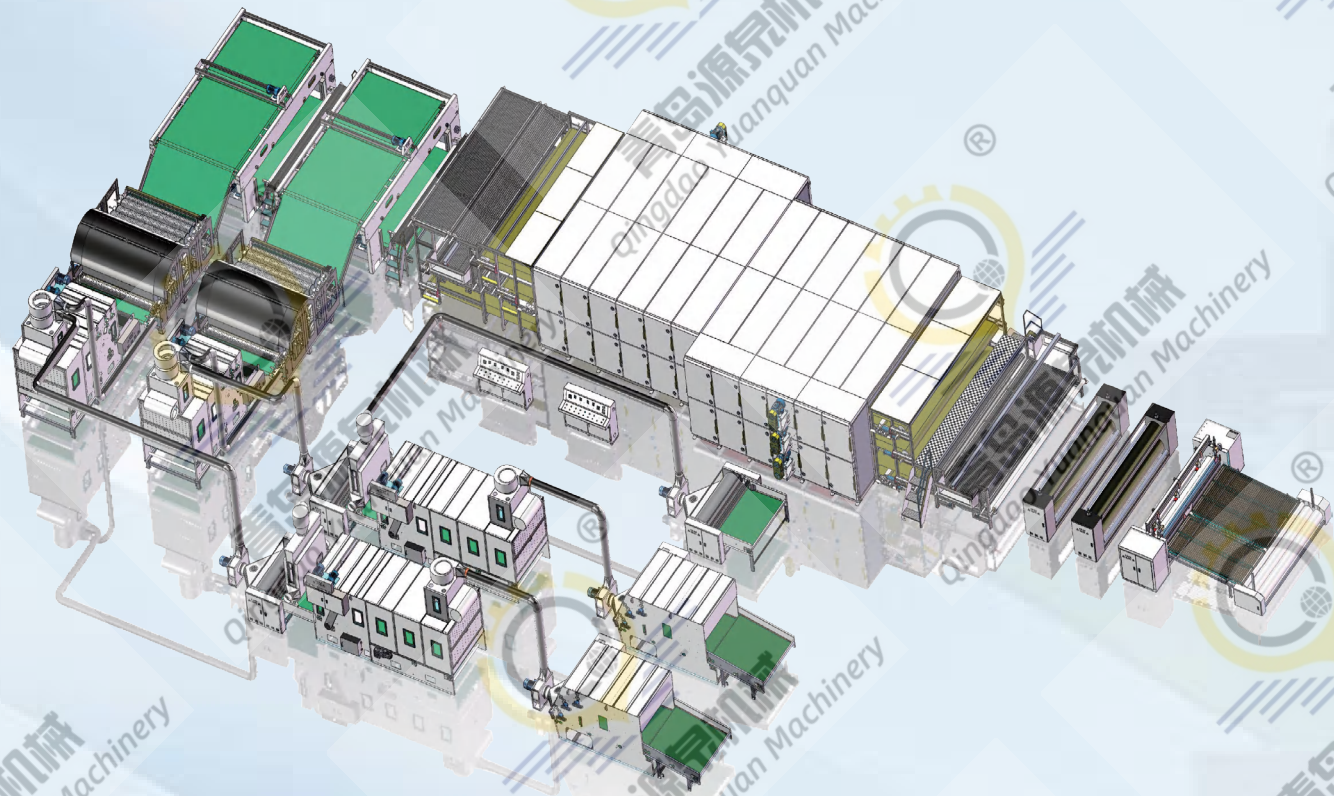

## 喷胶棉生产线

### Glue Spraying Wadding Production Line

喷胶棉设备主要生产高弹喷胶棉、仿丝棉。热熔棉、滤材等上胶、烘干、定型之用、设置前后（正反）喷胶，三层烘干工作区。该产品广泛应用于服装、床上用品、家具等。该生产线可根据客户需求定制不同配置的生产线，如双头喷胶棉生产线，多机头喷胶棉生产线等。

Chemical bonded wadding production line mainly produces high-elastic spray-bonded product and imitation silk product. Used for gluing, drying and shaping hot melt fiber, filter materials, etc. The oven is set up with glue spraying before and after (front and back), and a three-layer drying work area. Its finished product is widely used in clothing, bedding, furniture, etc. This production line can be customized with different types according to customers' requirements, such as double heads spray-bonded production line Multi-head spray-bonded production line and etc.



# 生产线系列 PRODUCTION LINE SERIES

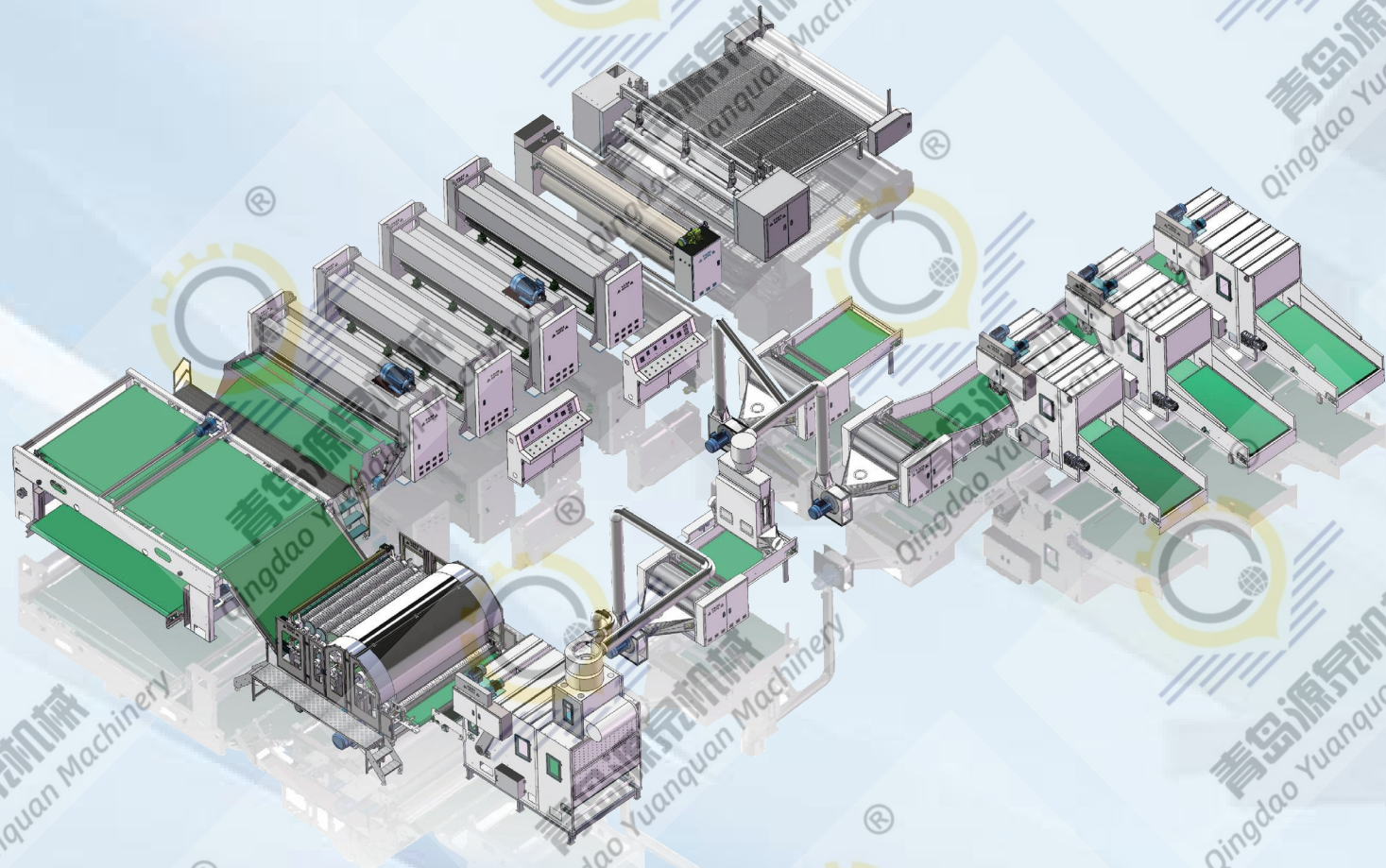

## 针刺生产线 Needle Loom Production Line

针刺无纺布是非织造布中一种，是将短纤维经过开松、梳理、铺成纤维网，然后将纤维网通过刺针加固成布，刺针有钩刺，将纤维网反复穿刺，钩带纤维加固，形成针刺无纺布，

Needle-punched non-woven fabric is a kind of non-woven fabric. Short fibers are opened, carded and laid into a fiber web, and then the fiber web is reinforced into cloth through felting needles. The felting needles have hooks and repeatedly puncture the fiber web, and the hooks are Fiber reinforcement to form needle-punched non-woven fabric,

用途特点：适合一般非织造布，如针刺棉生产线、油毡基布生产线、土工布生产线、地毯生产线、被子生产线、汽车内饰无纺布生产线、合成革基布生产线、百洁布生产线等。可根据客户需求定制。

Suitable for general non-woven fabrics, such as needle-punched cotton production line, linoleum base fabric production line, geotextile production line, carpet production line, quilt production line, automotive interior non-woven fabric production line, synthetic leather base fabric production line, scouring pad production line, etc. Can be customized according to customers' needs.

